

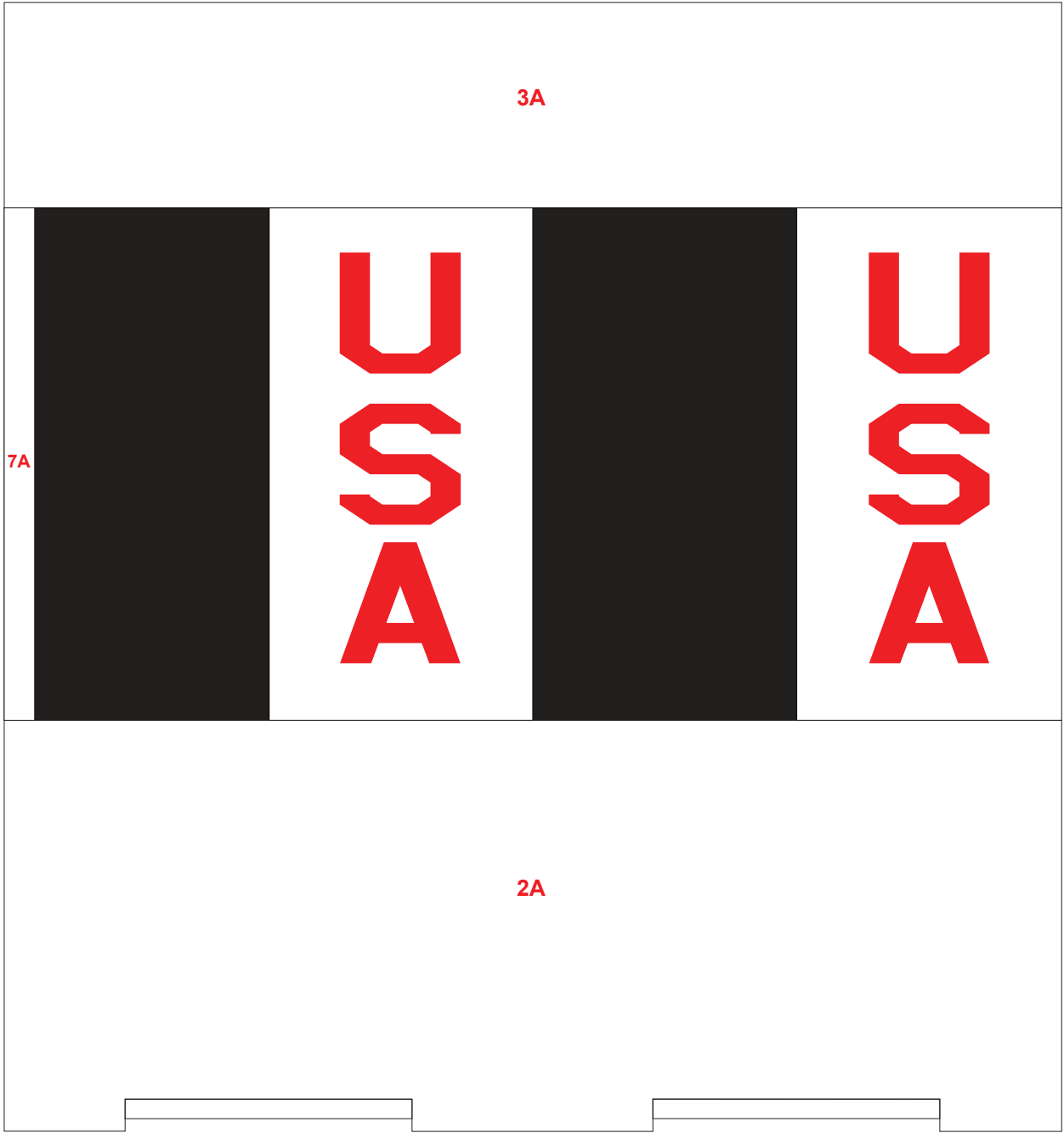

1A

Part 1A Side Tab



Part 1A Top Tab

2A

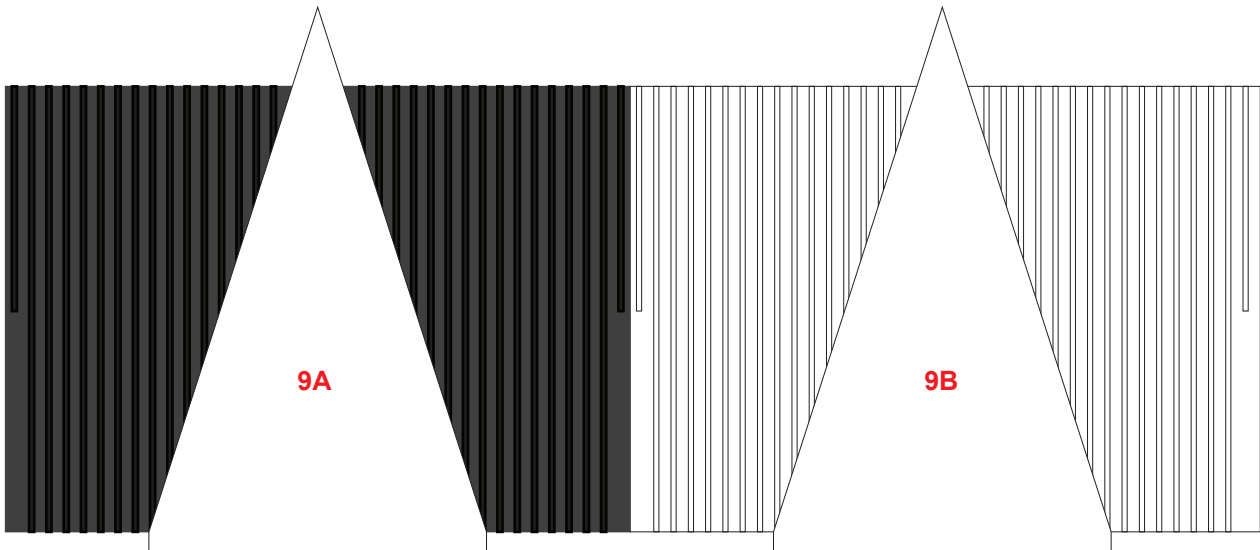



1B

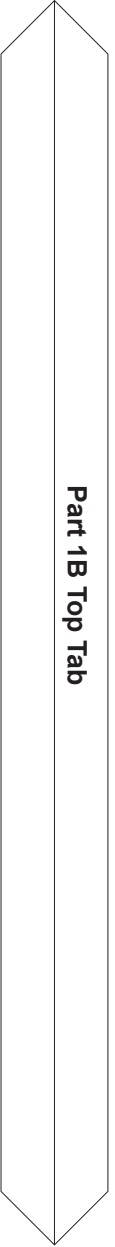
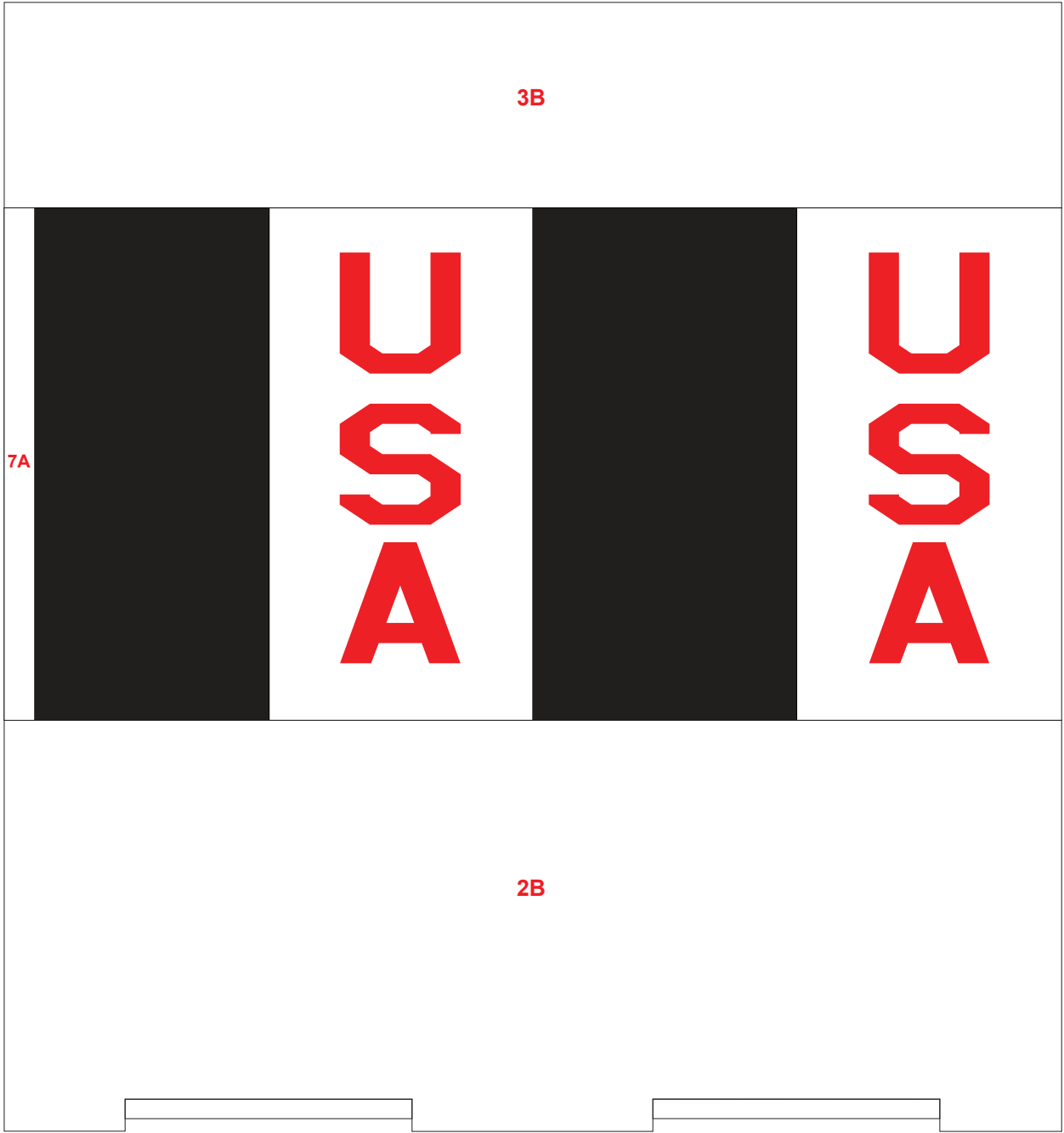

2B

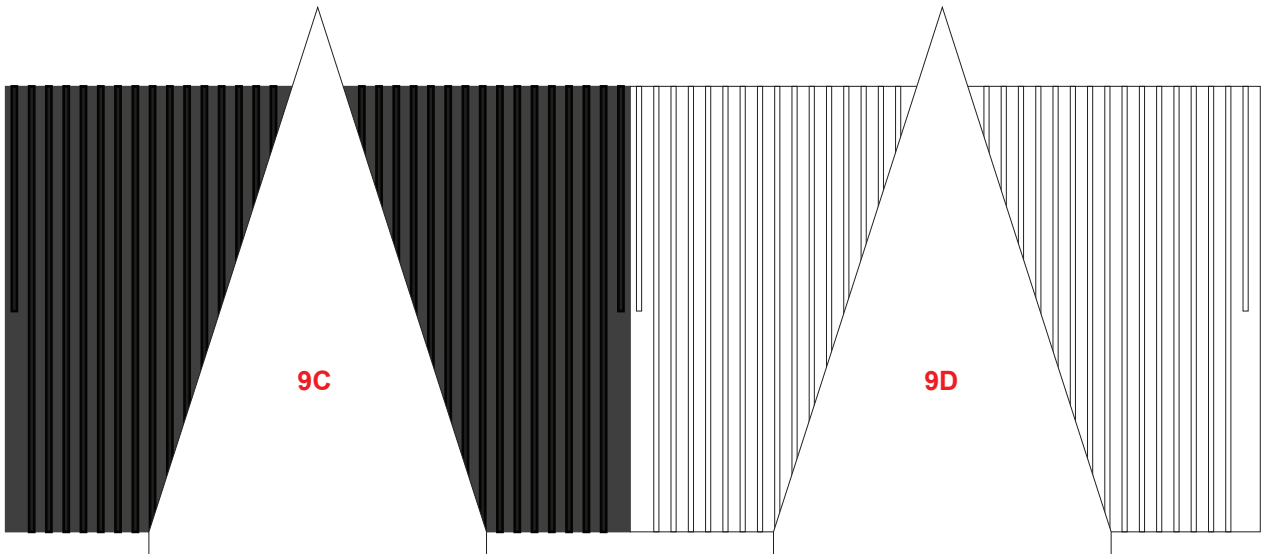



5A

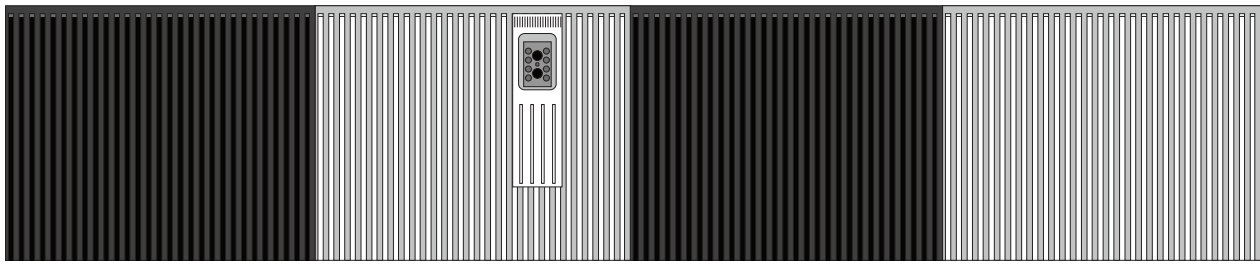

5A

4A

8A

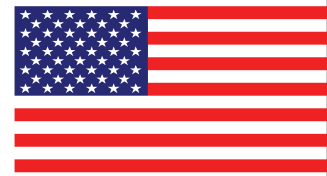
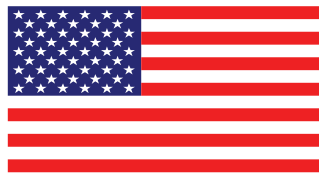

3A

Part 4A Side Tab





5B

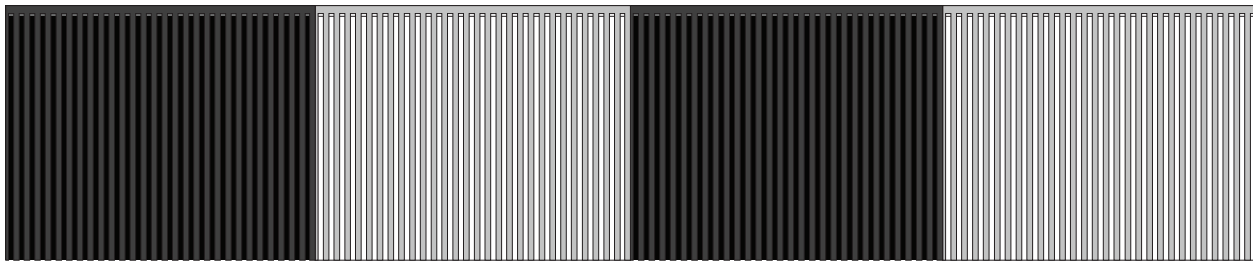

5A



4A

8B

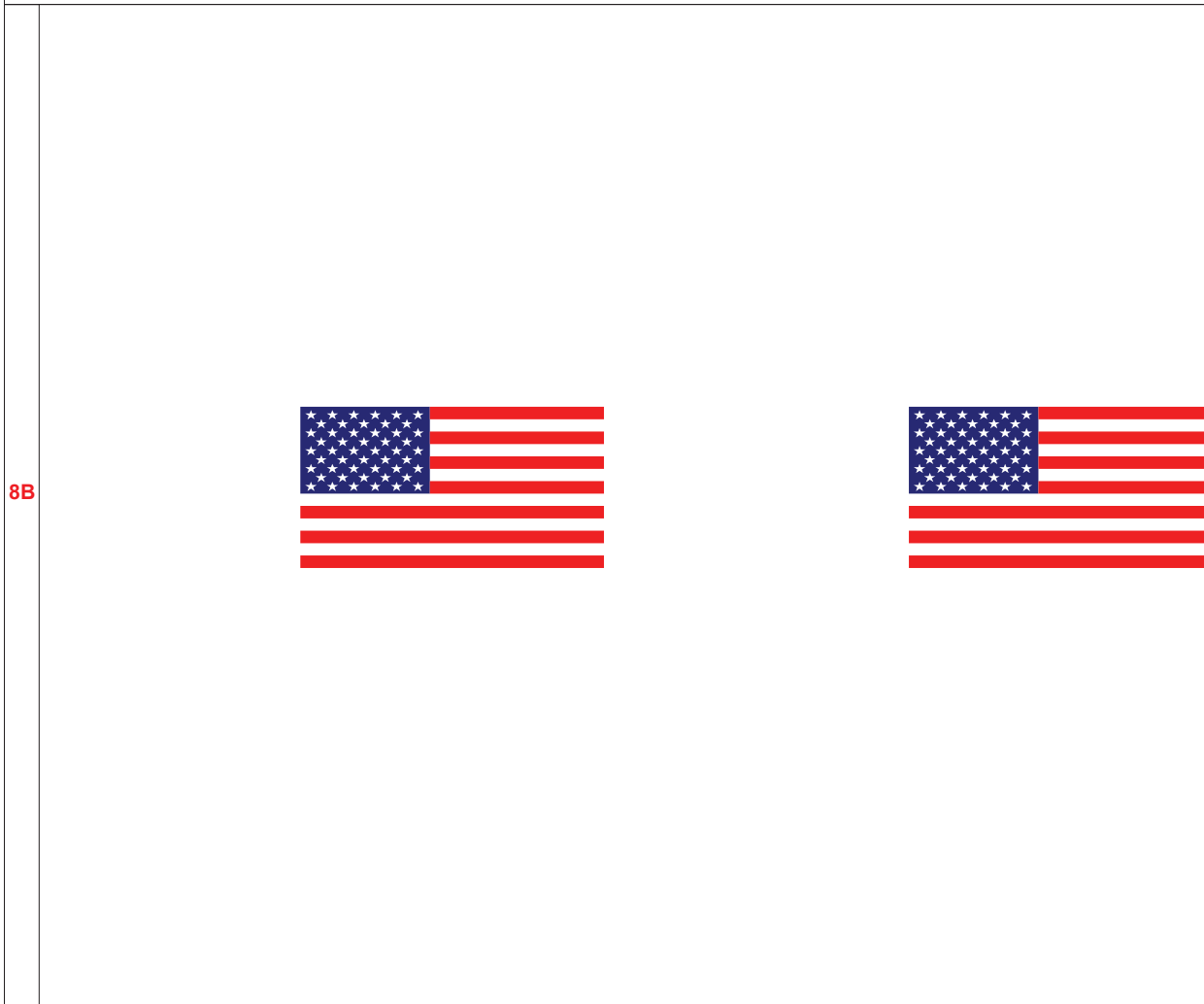

3A

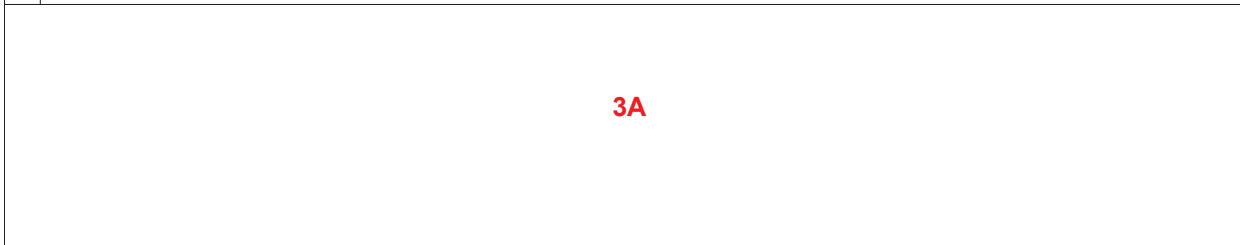

Part 4B Side Tab



3A

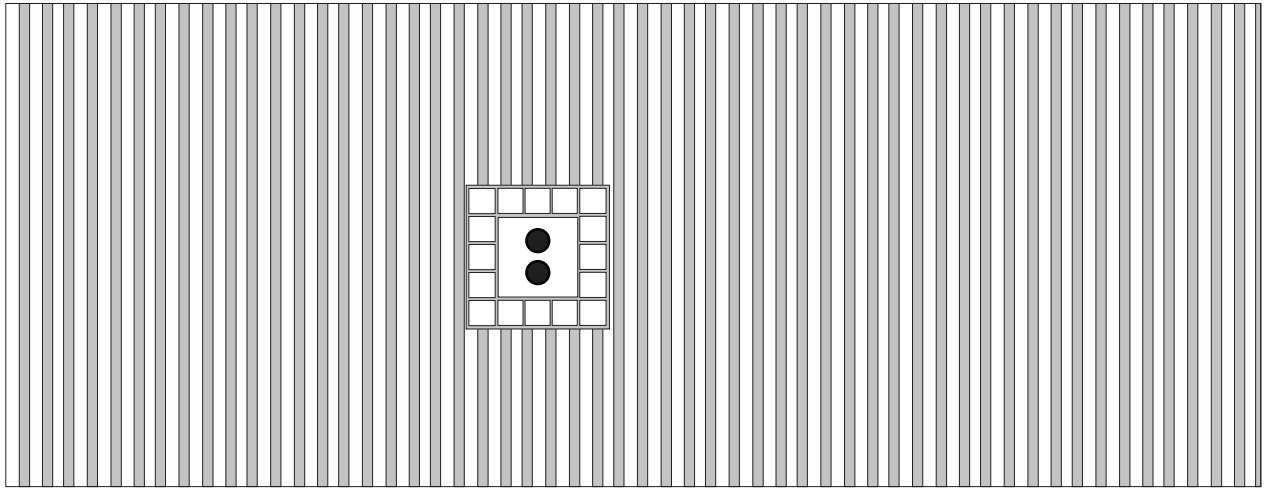

3B

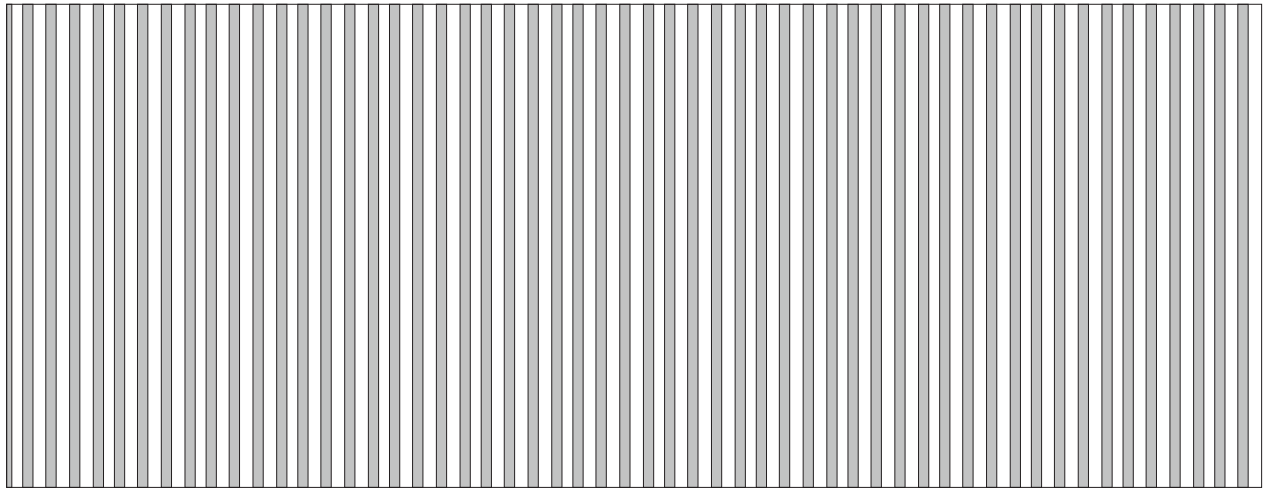

6A



6B

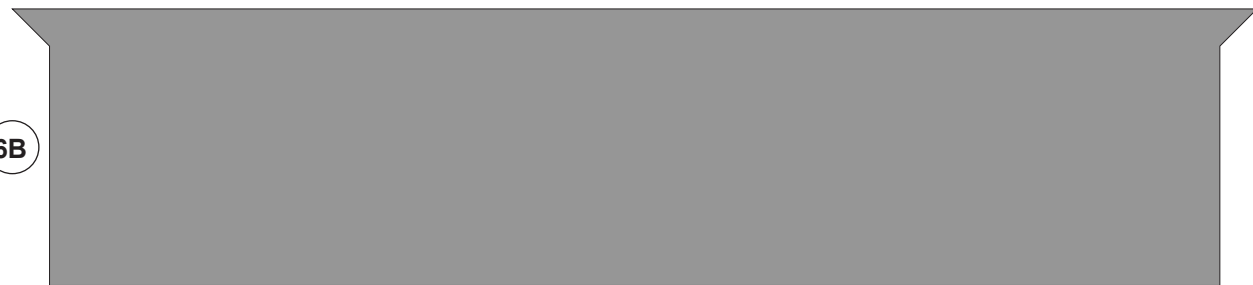

7B

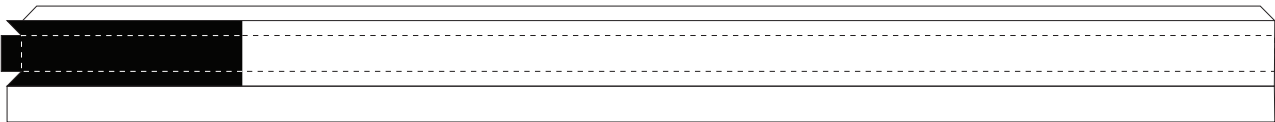

7A

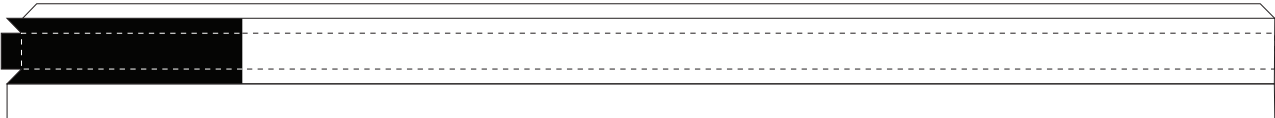

PART 7 & 8 TAB



8A



8B



9A

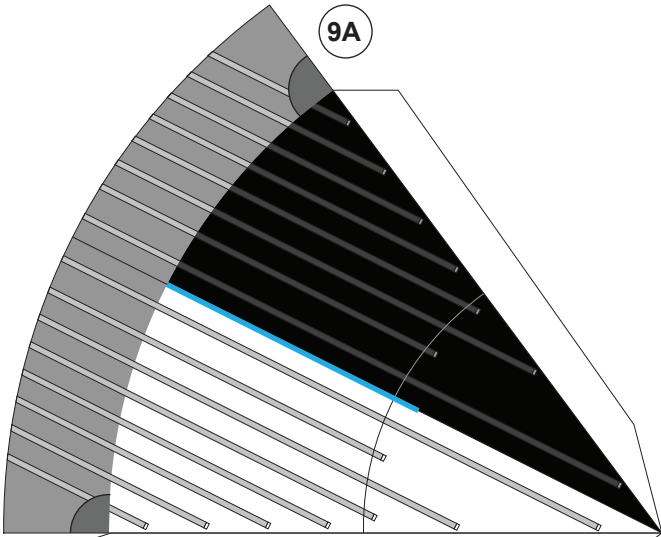

9B

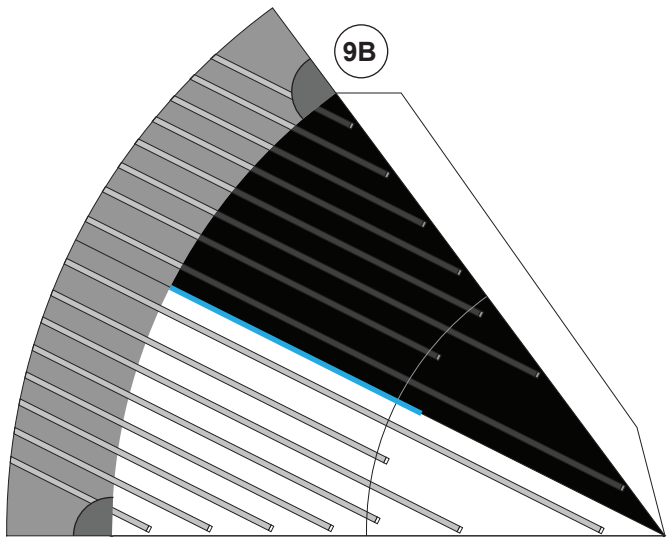

9C

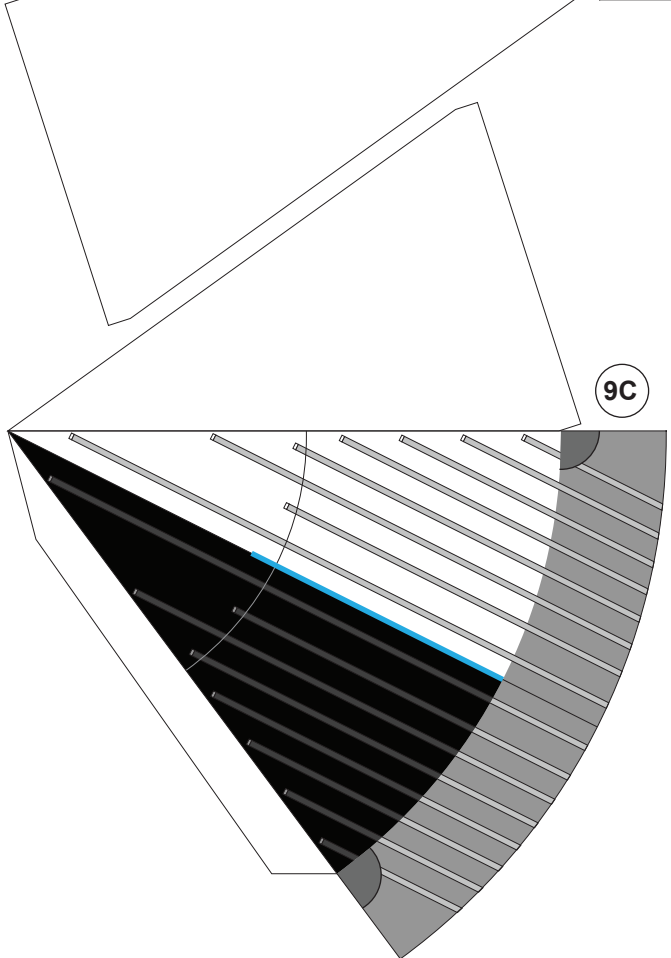

9D

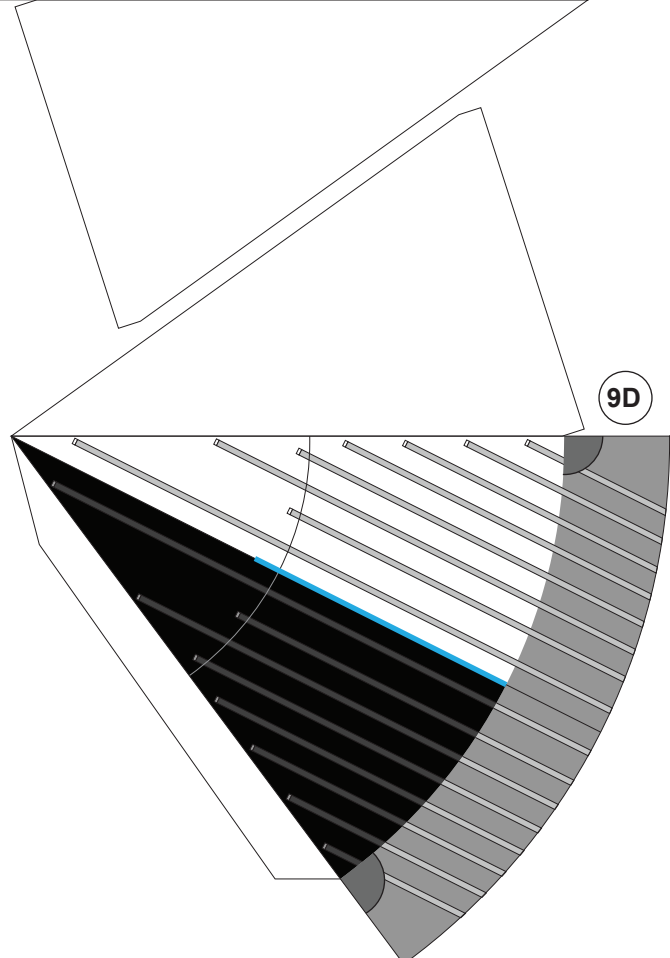

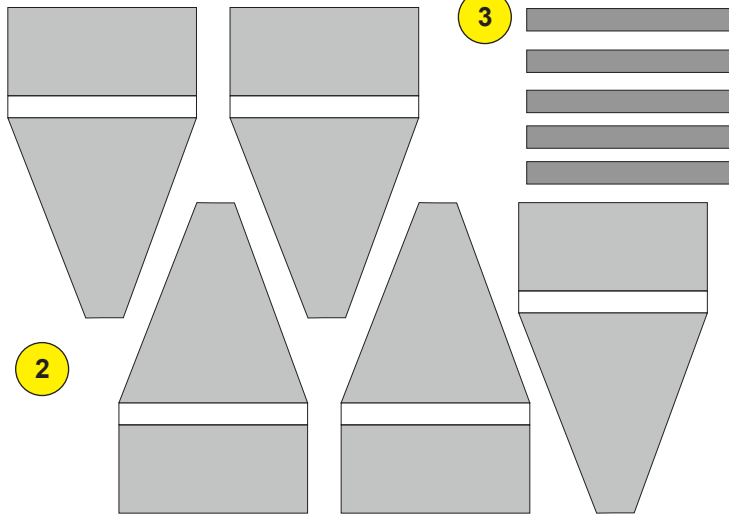
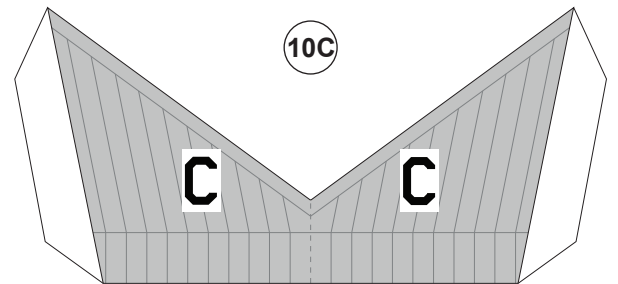
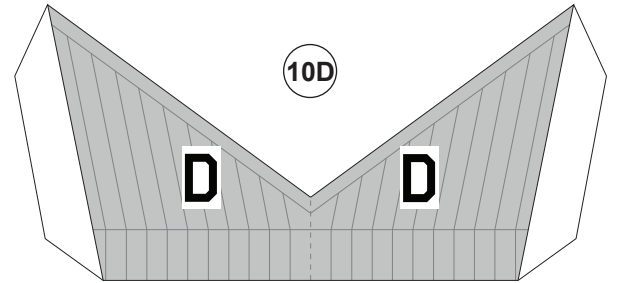
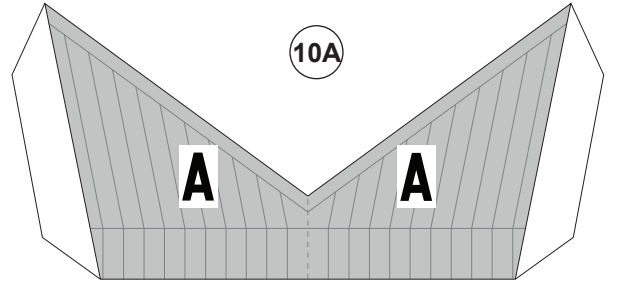
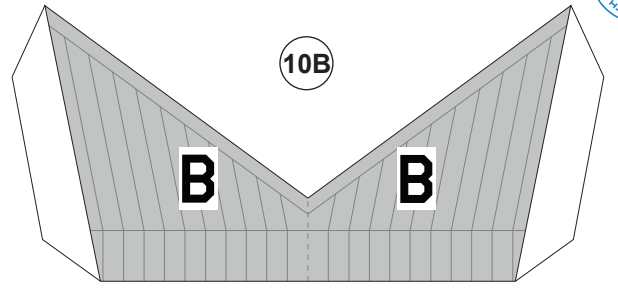
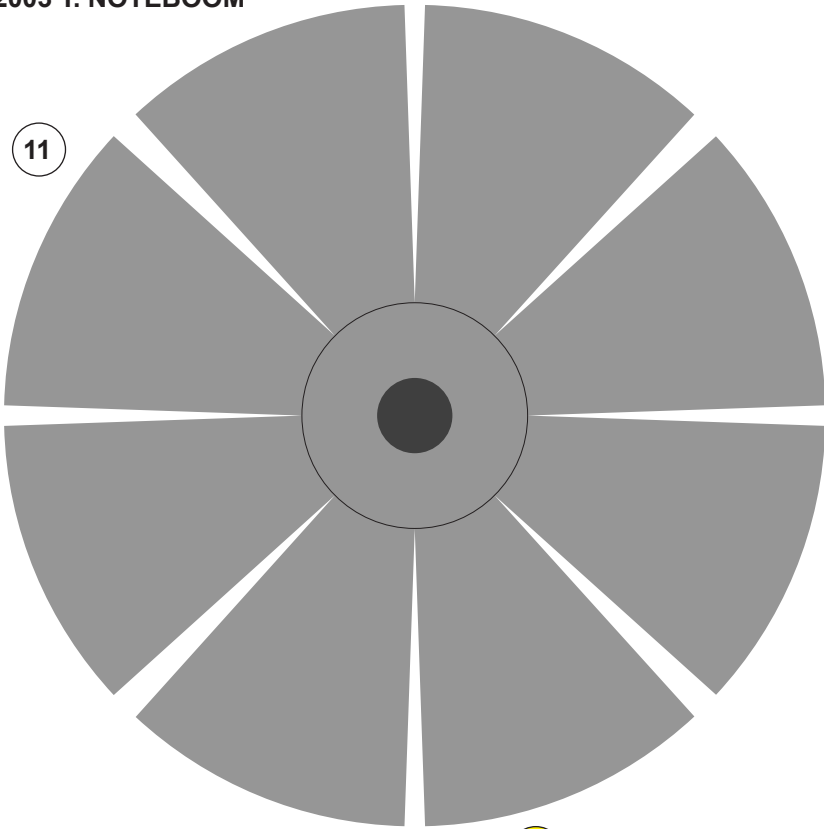

2

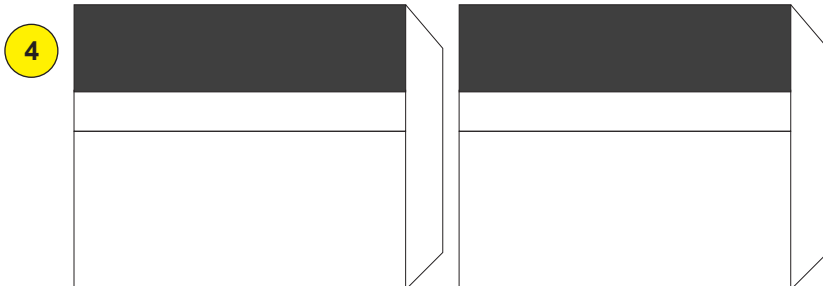

5



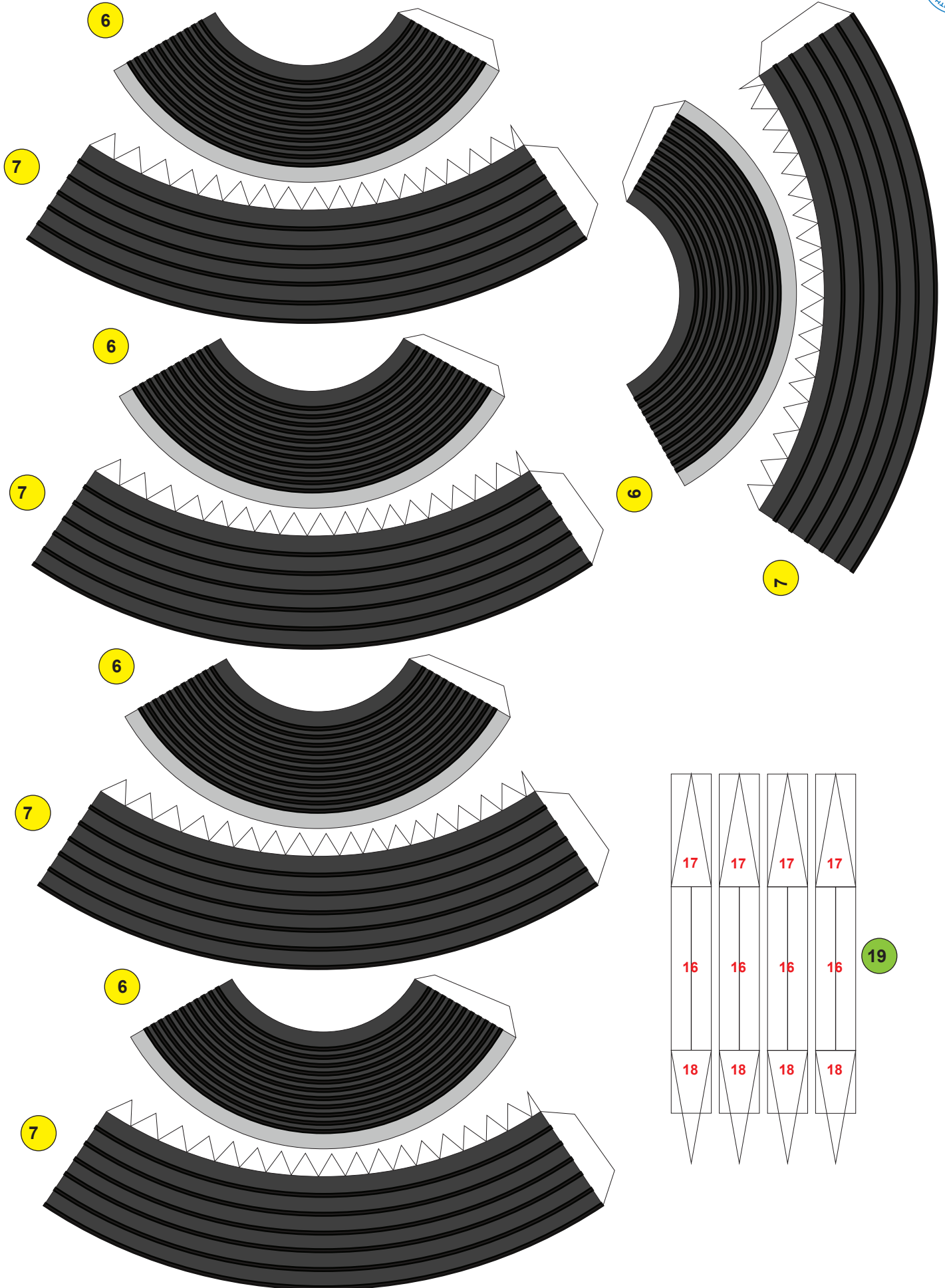



2A

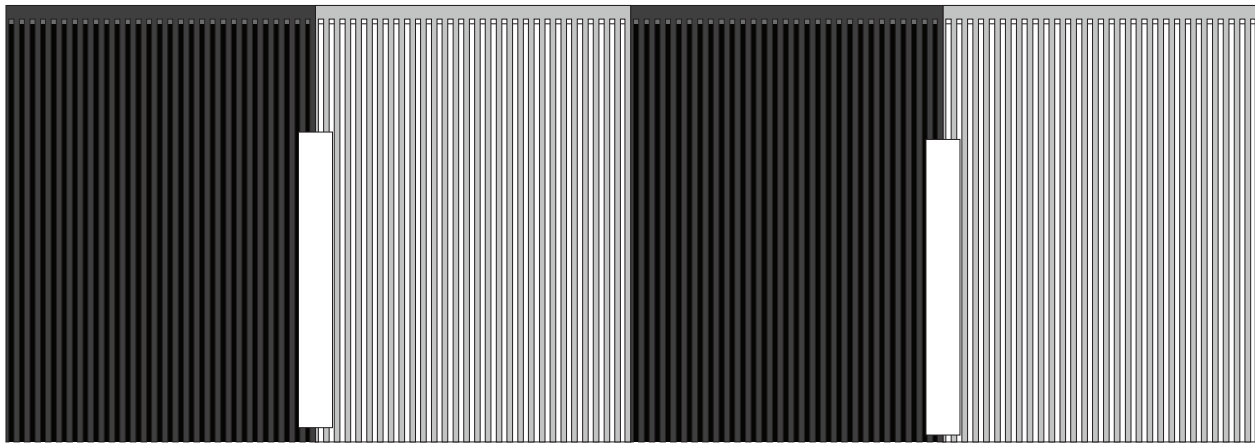

2B

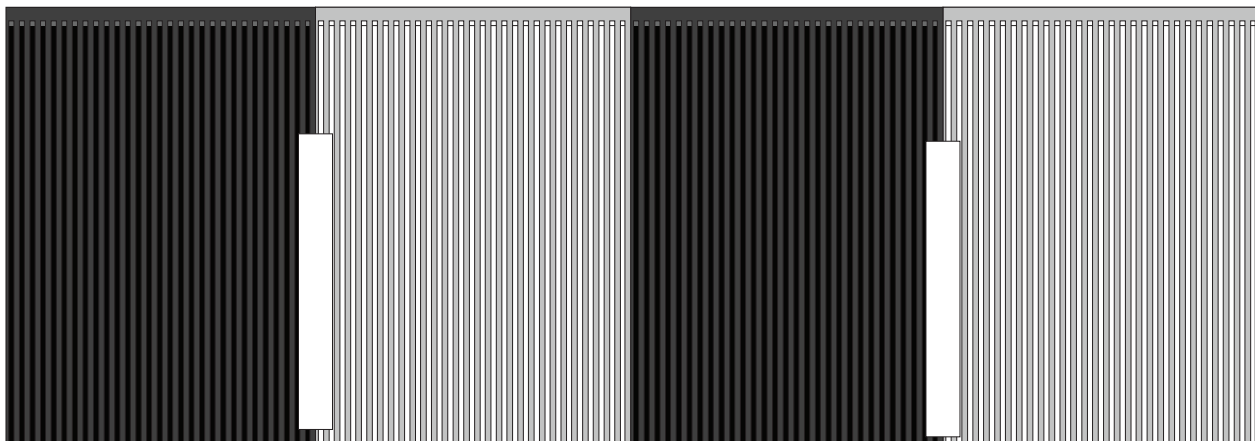

1A

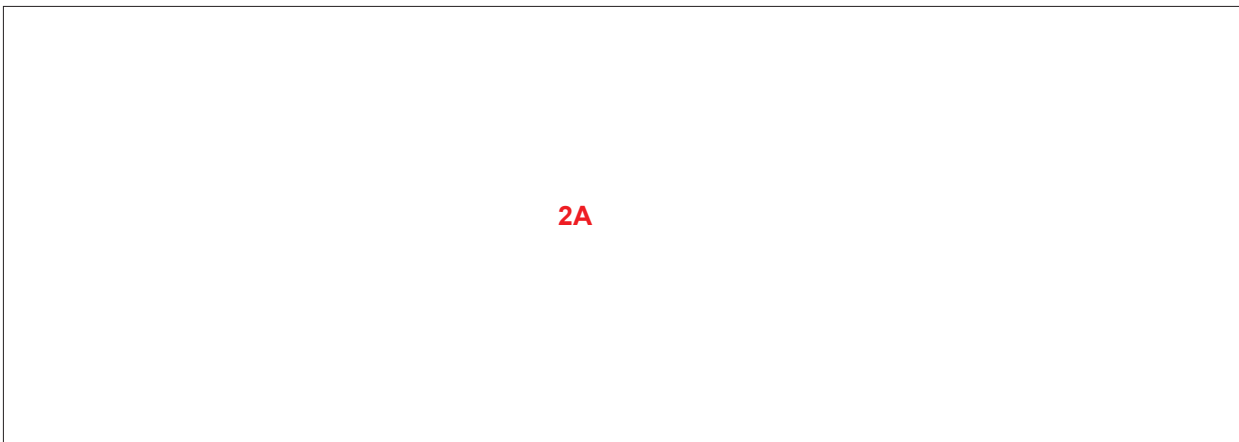

2A

1B

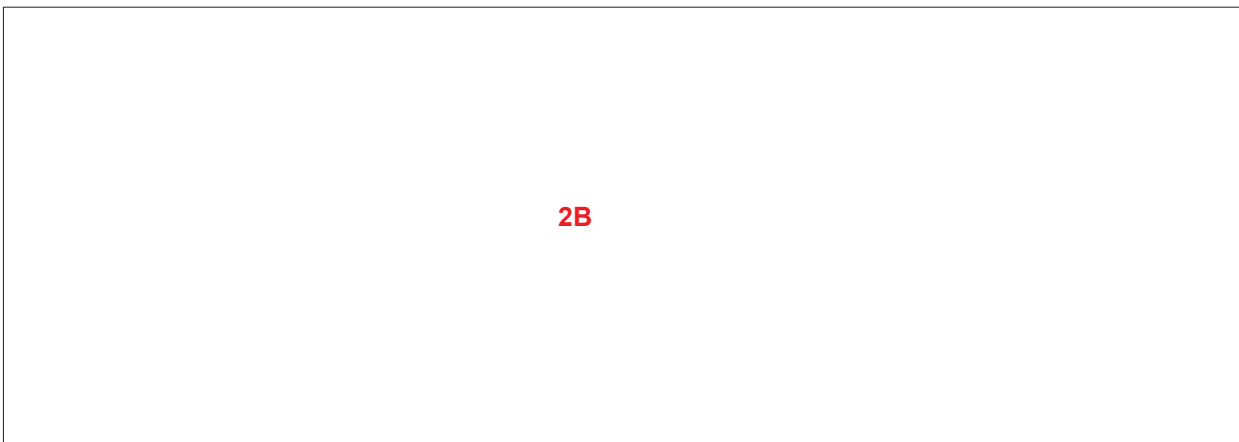

2B

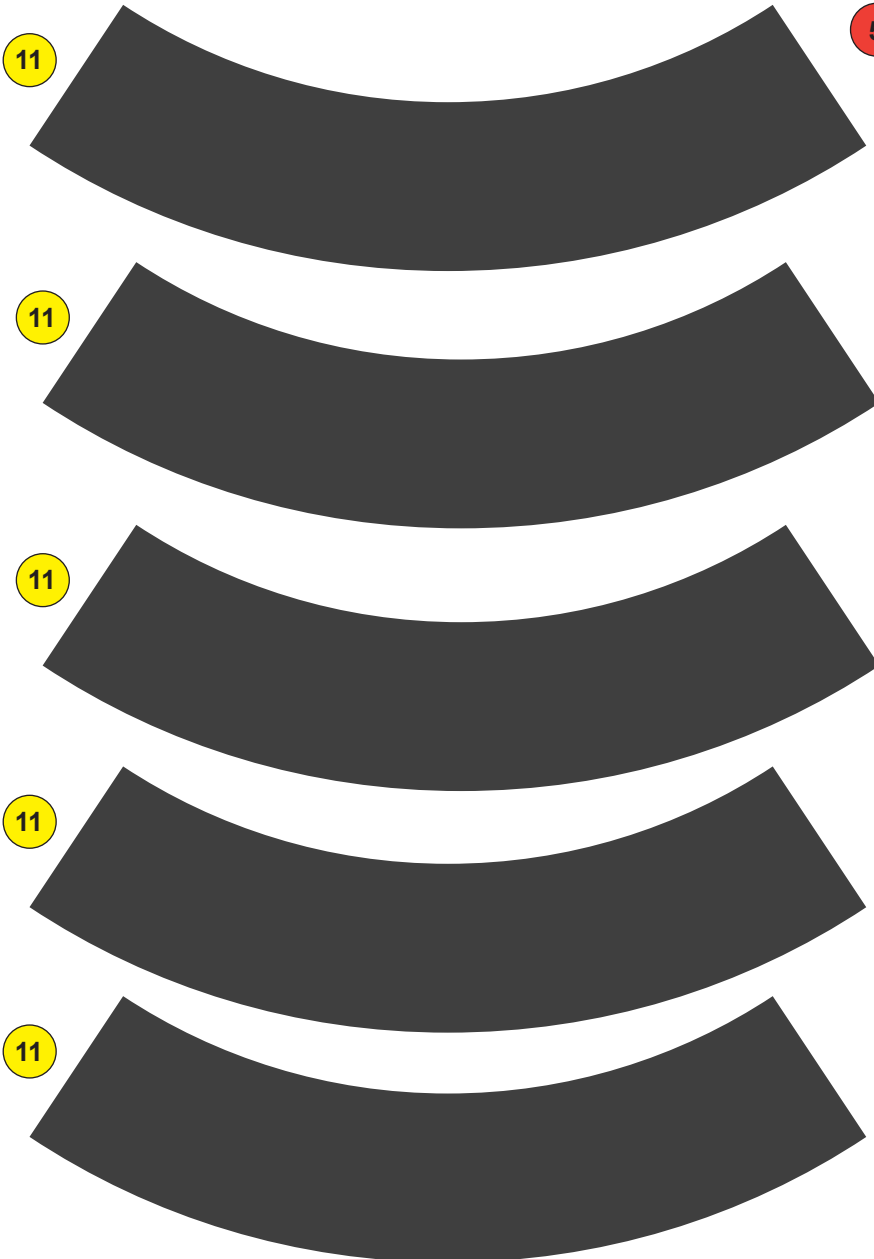

5

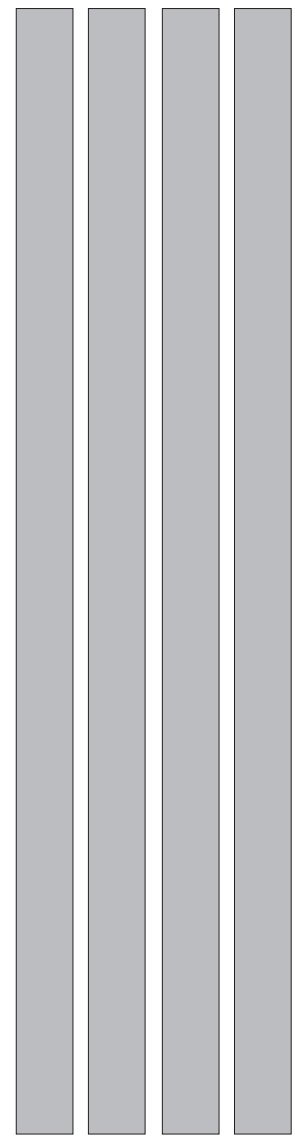

7

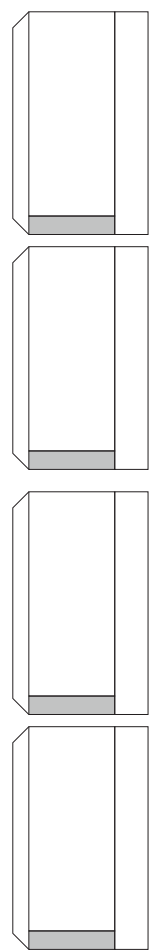

4

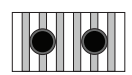

6

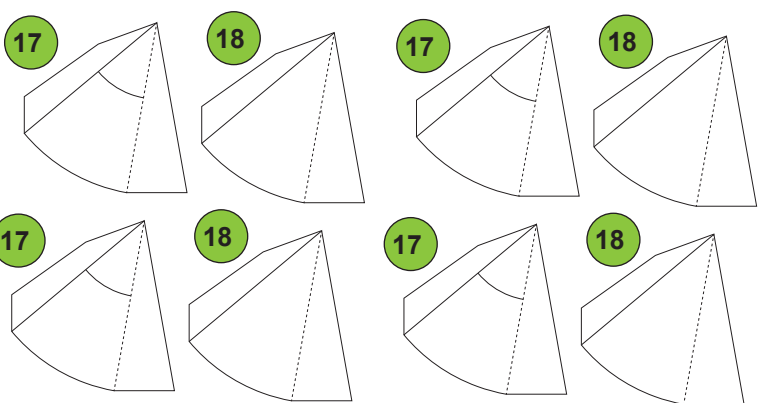
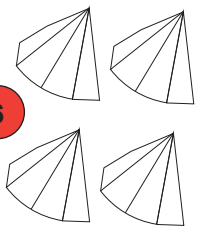

16

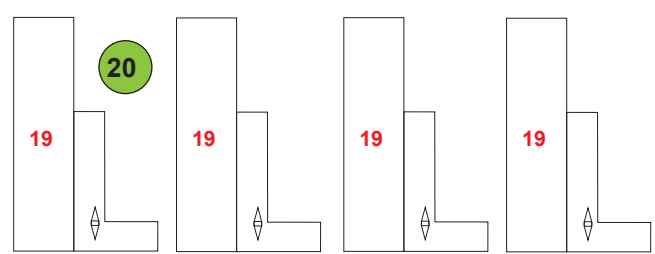
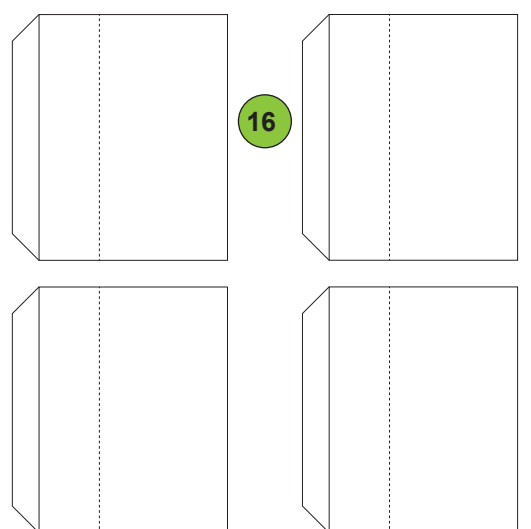



2A



3A

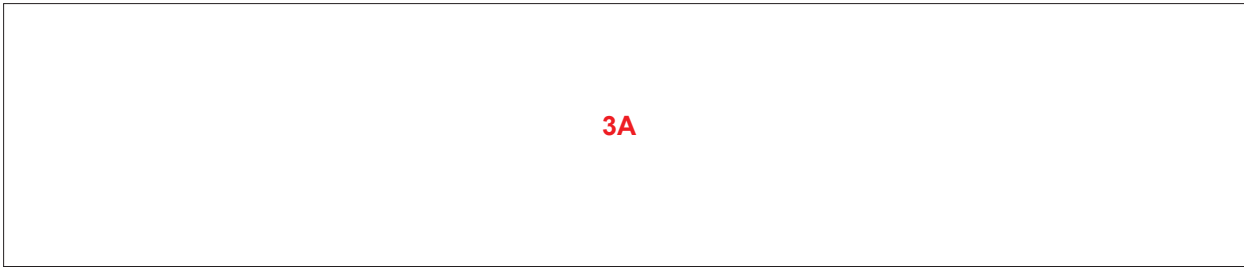

1A

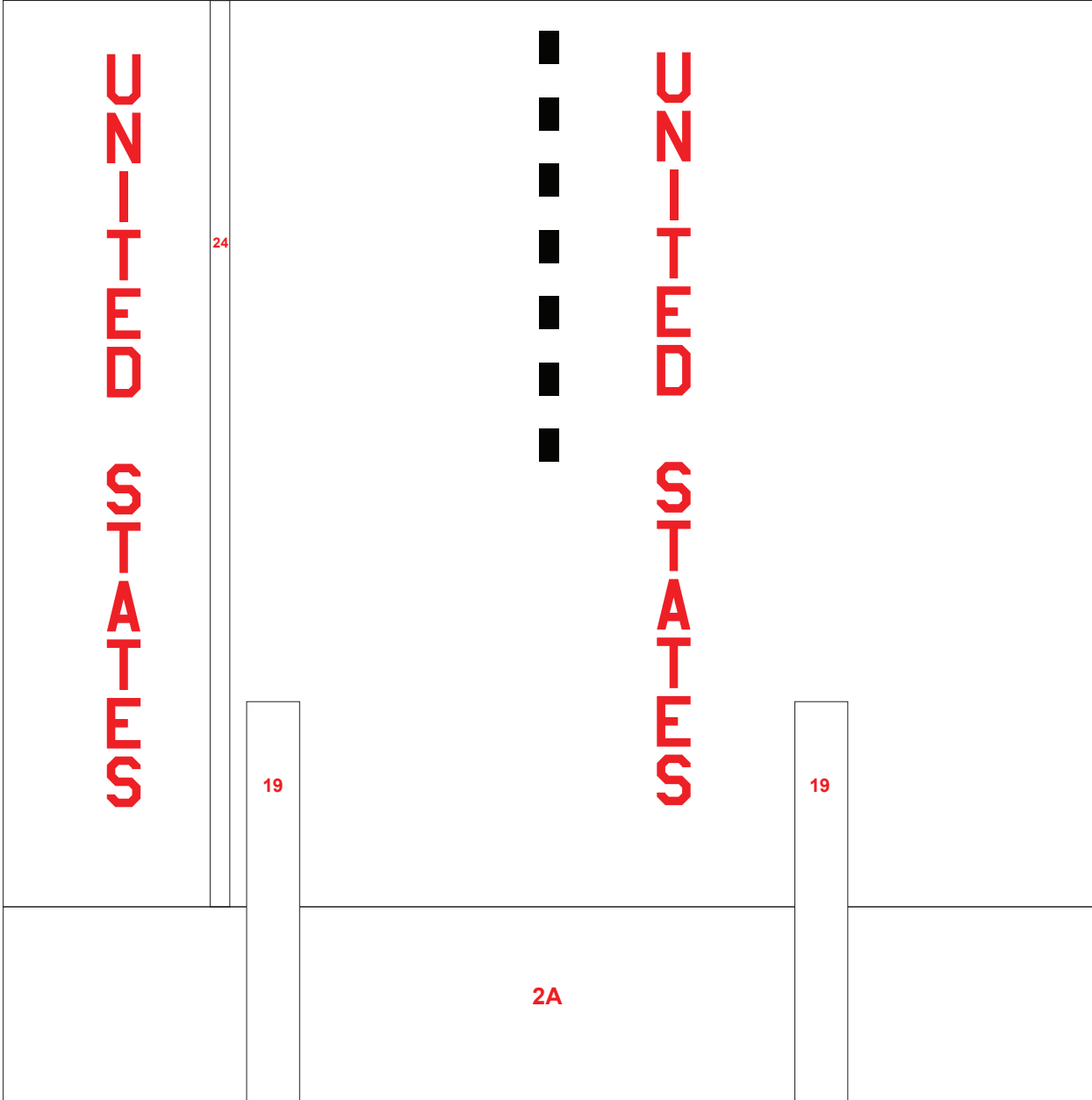

Part 1 A Side Tab





2B



3B

1B

UNITED STATES



UNITED STATES

19

19

2B

Part 1 B Side Tab

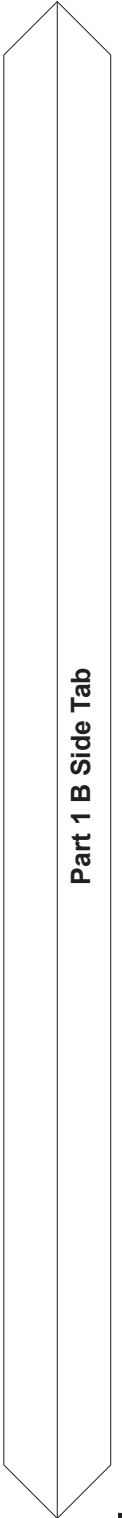



3A

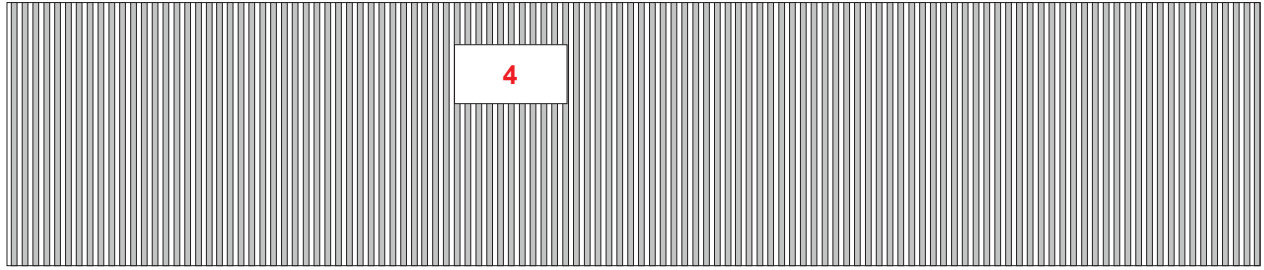

3B

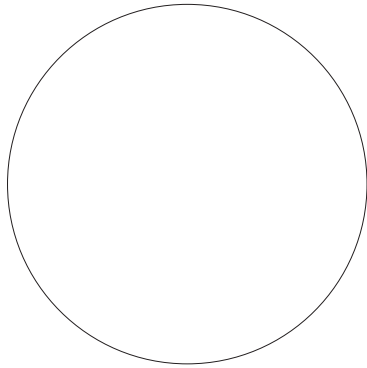
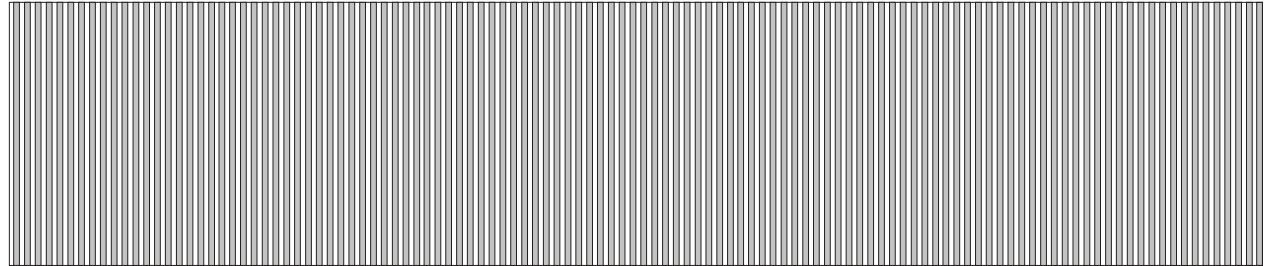

8

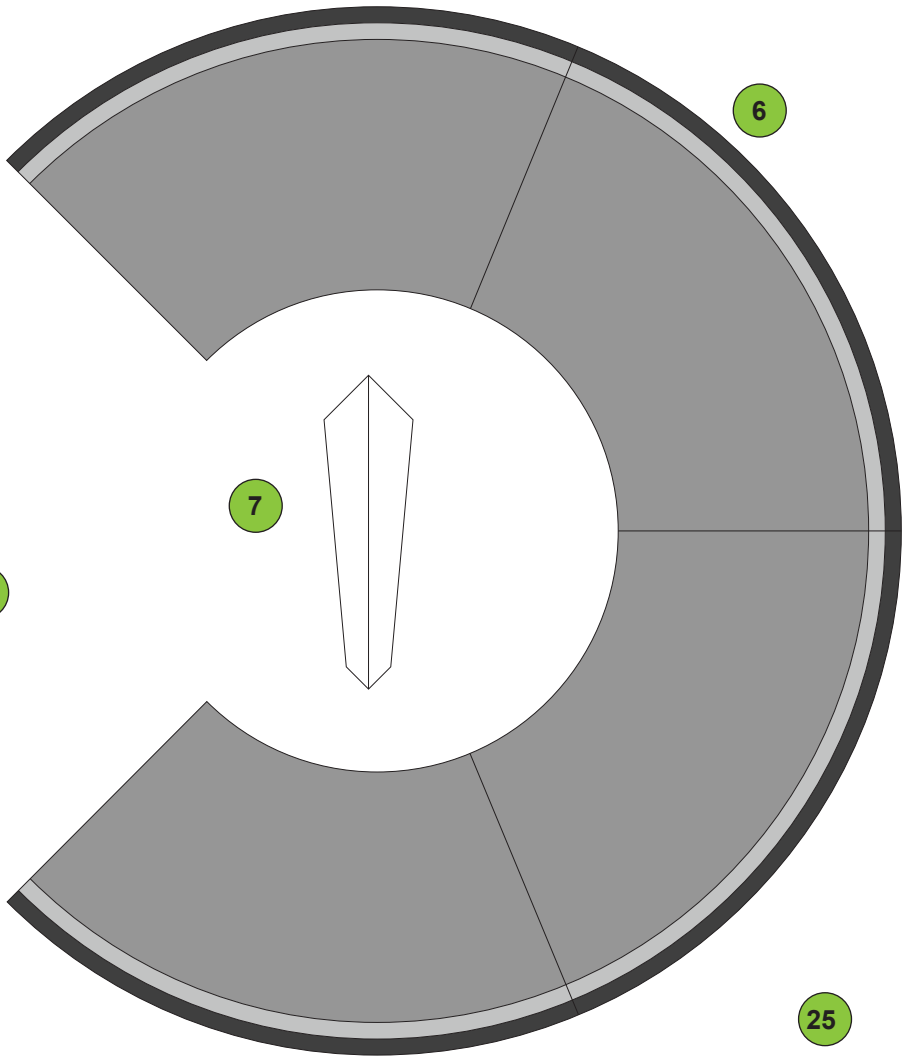

6

7



30

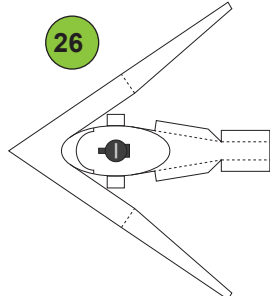

26

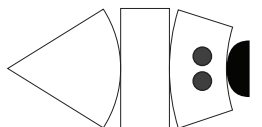

25



22

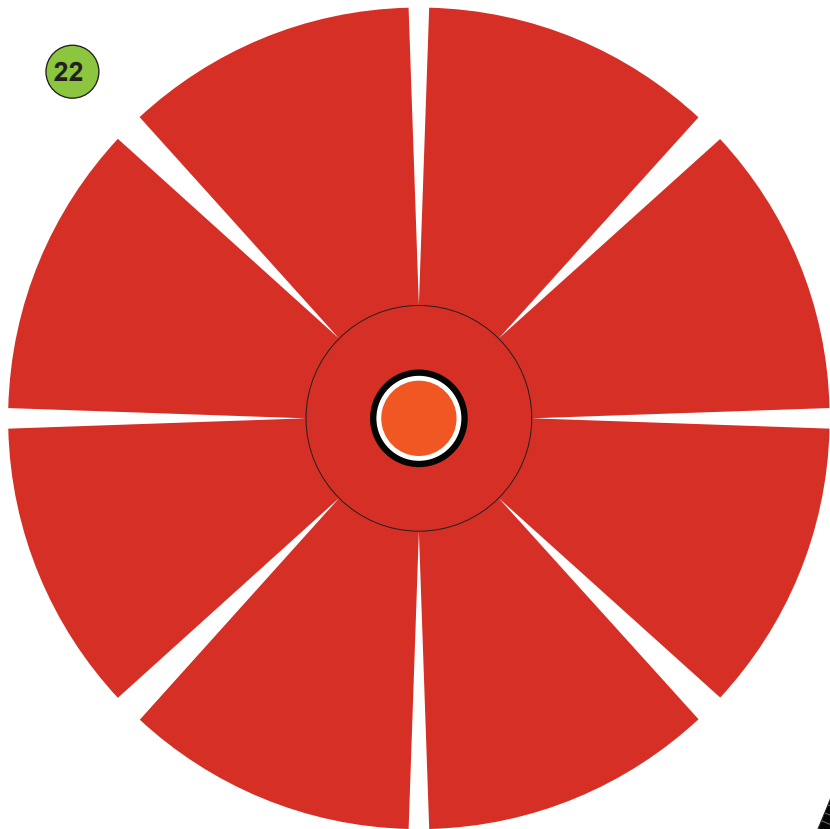

23

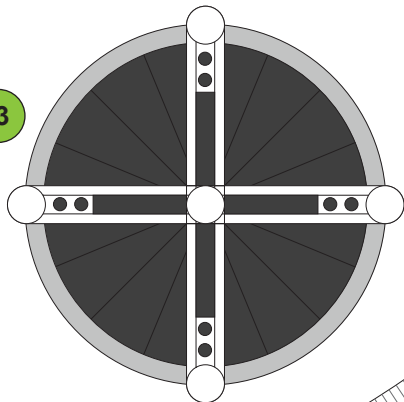

24

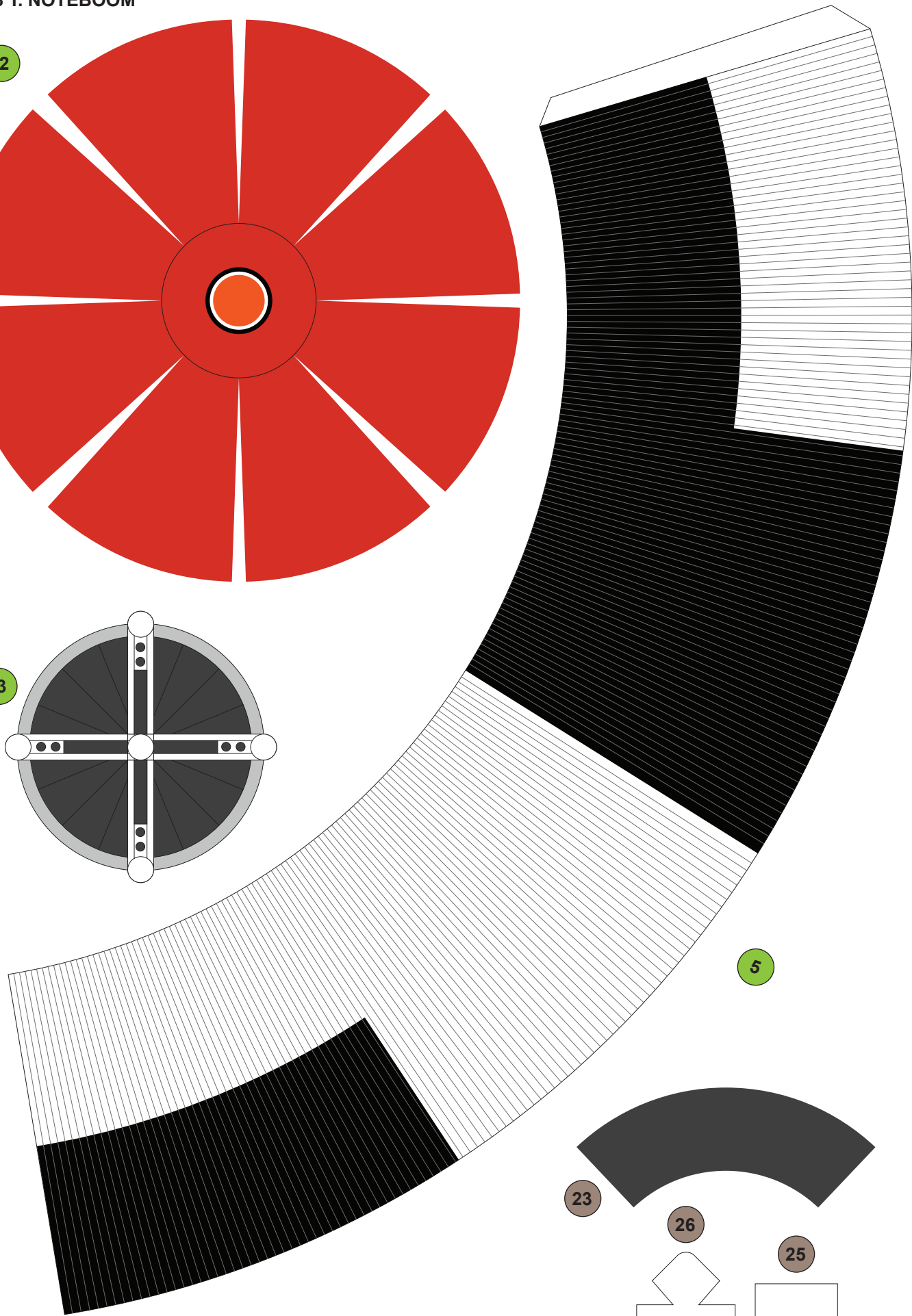

5

23

26

25

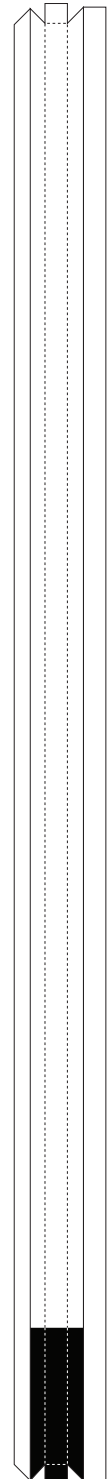
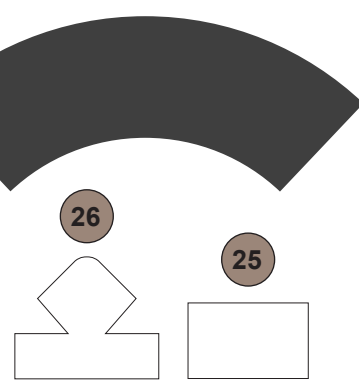



21A



21B

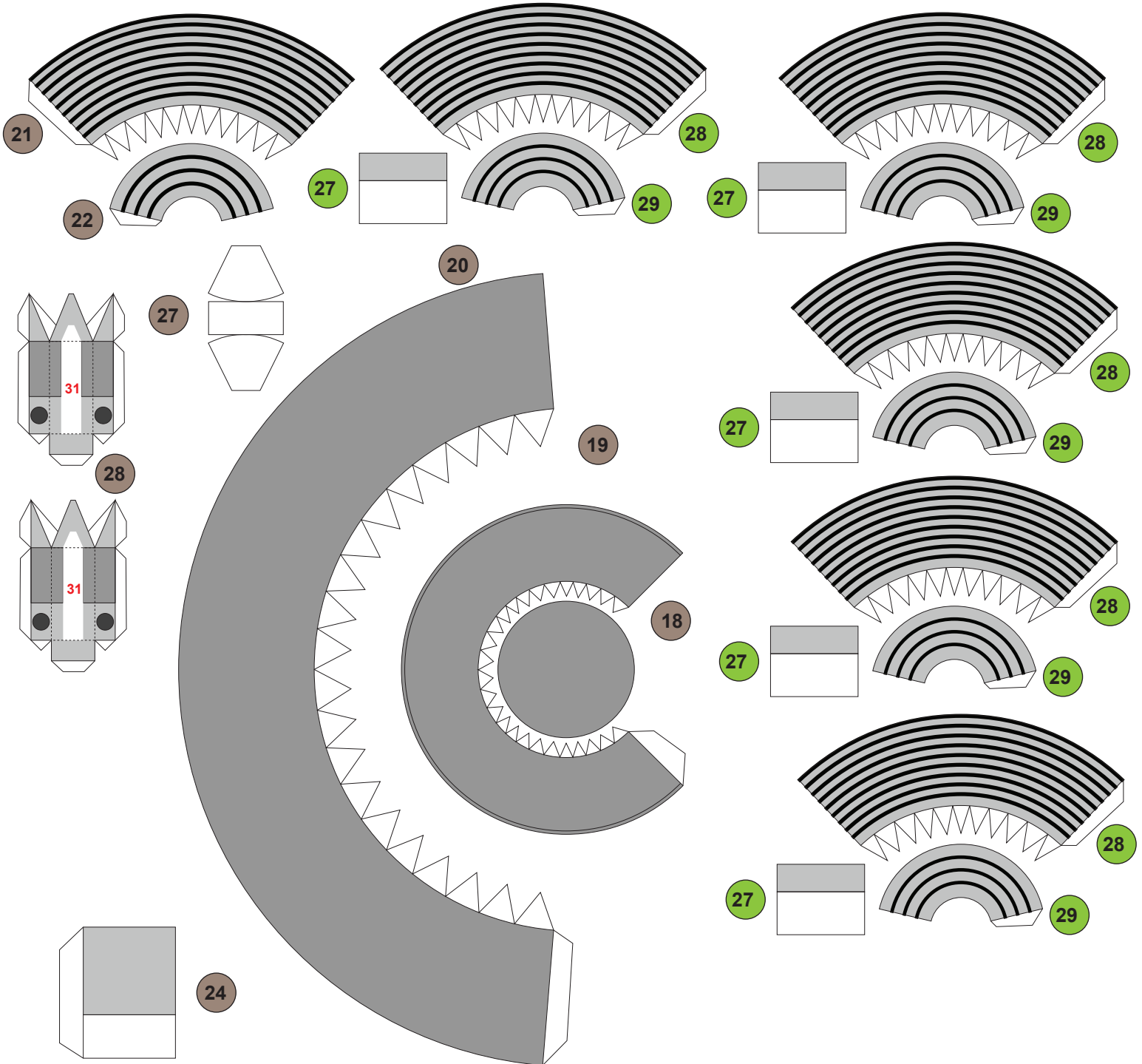

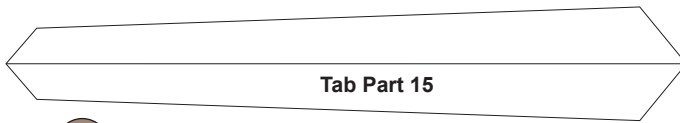
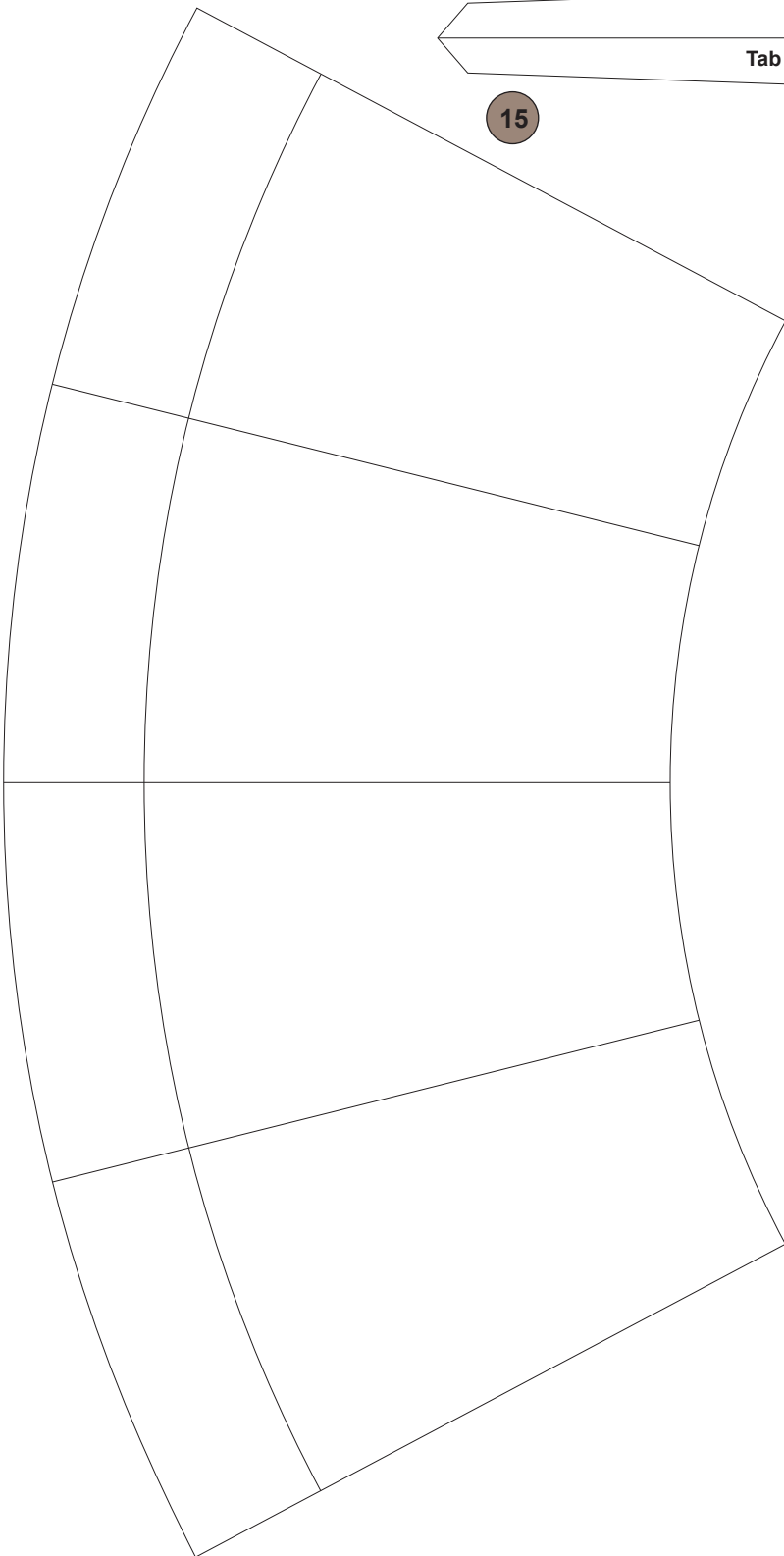

Tab Part 15

15

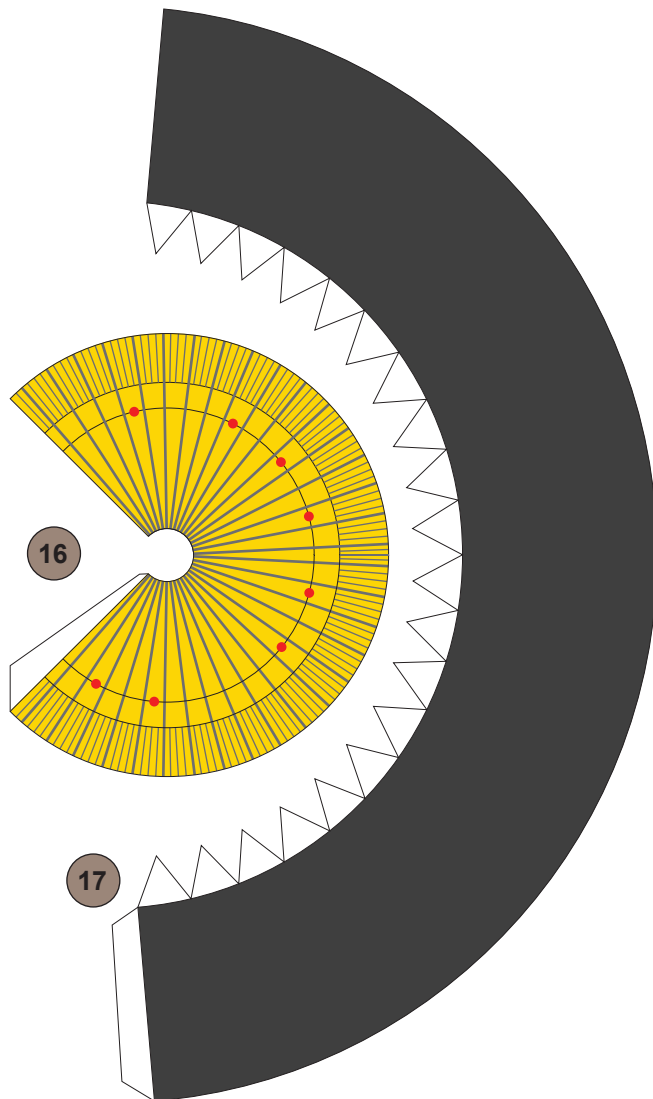

16

17

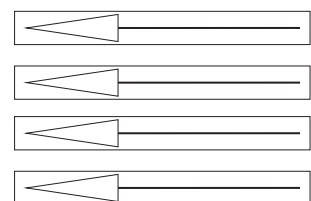

8

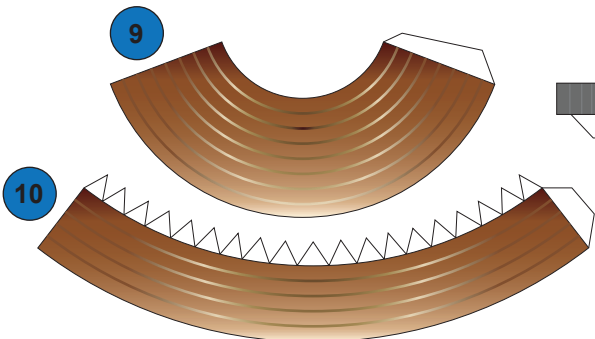

9

10

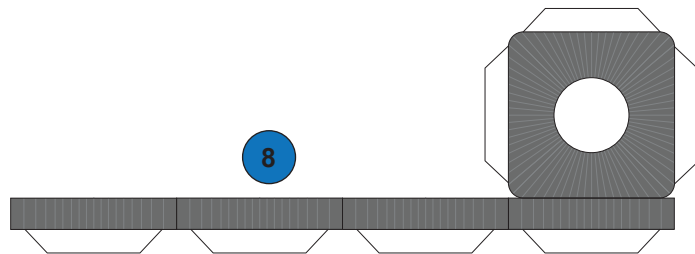

8

11



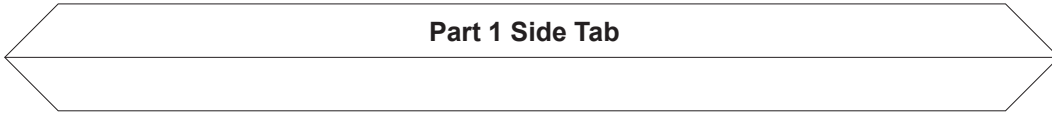

1

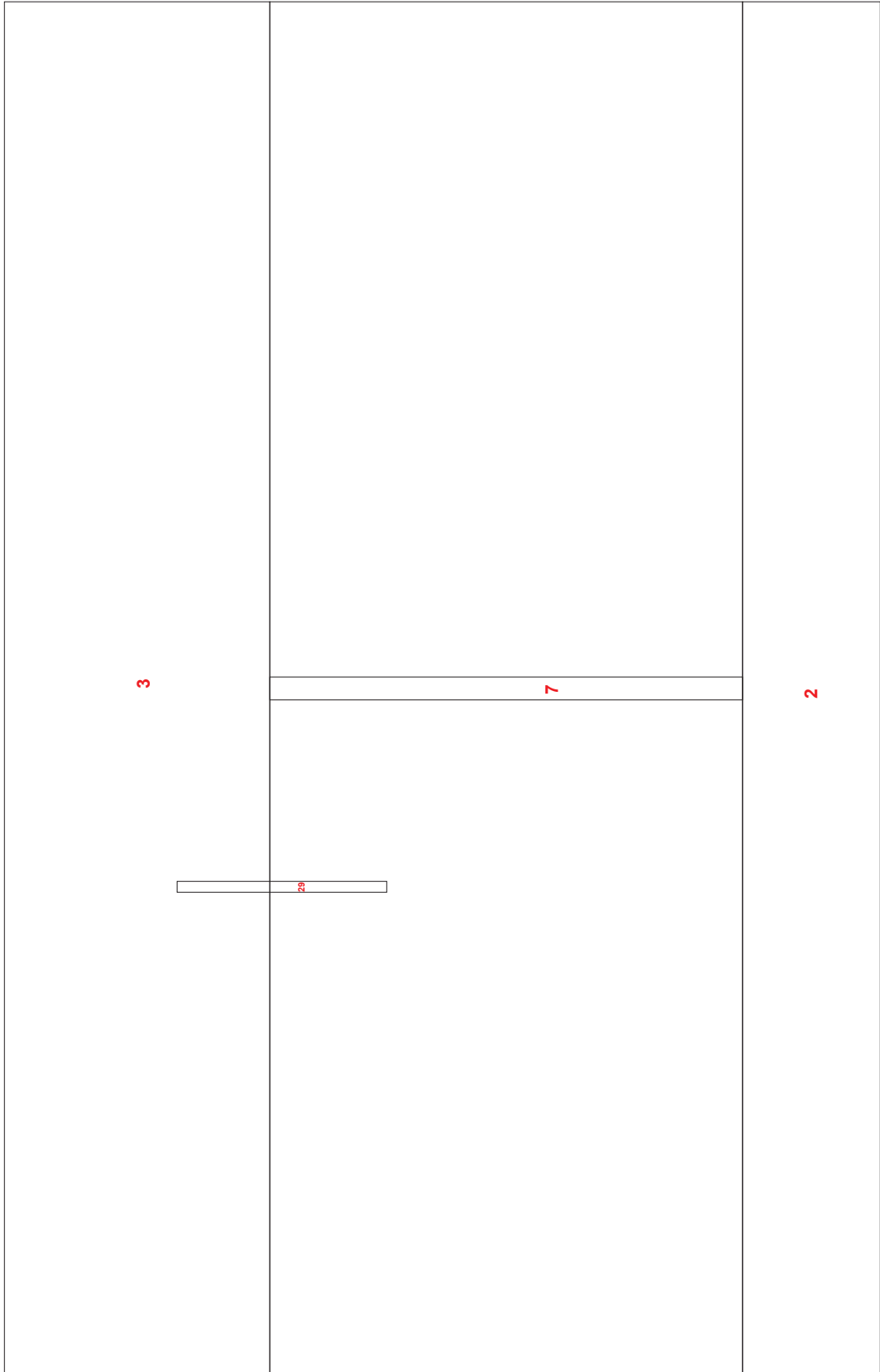

7

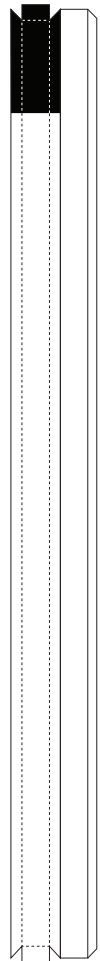

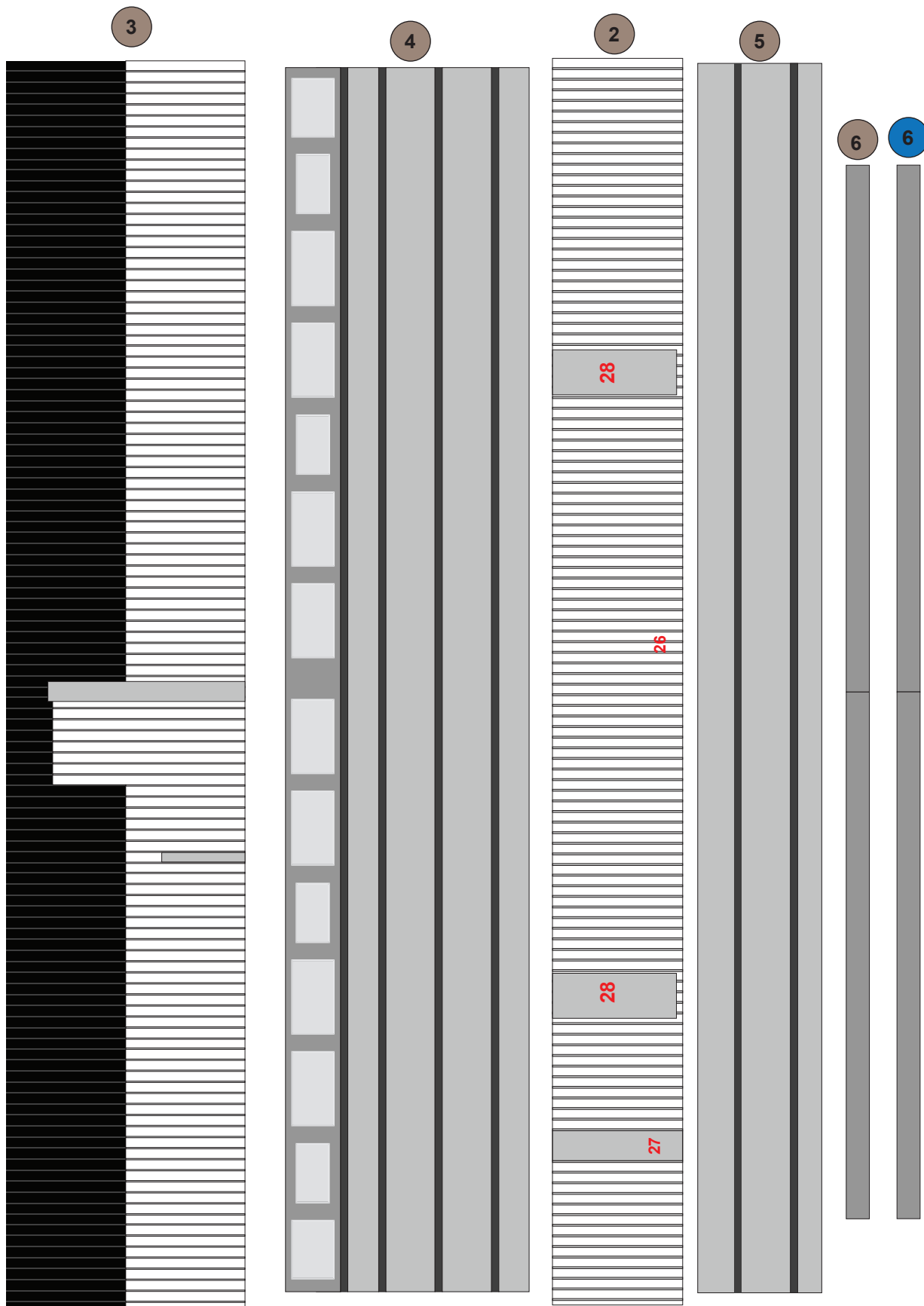

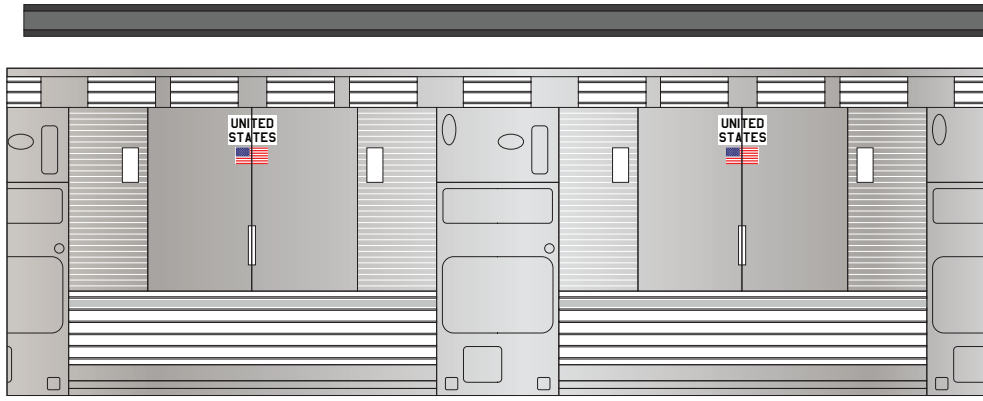

2

1



Tab Part 1

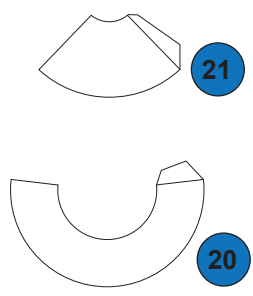

21

20

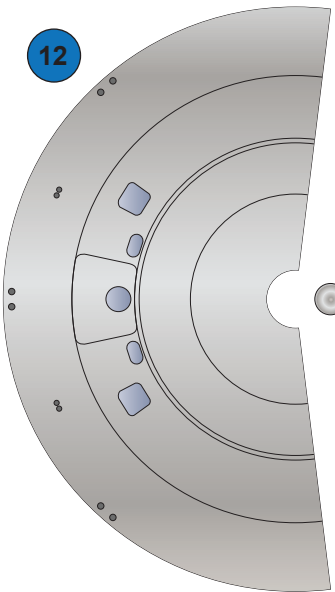

12

14
Connector to LEM
Optional



14

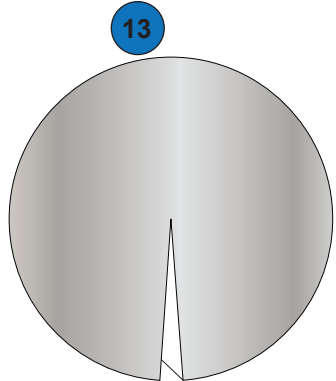

13

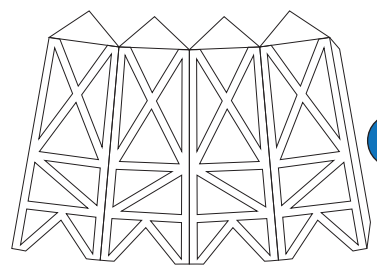

18

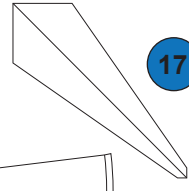

17

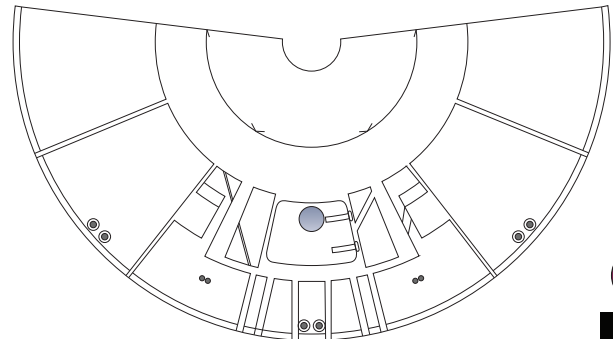

16

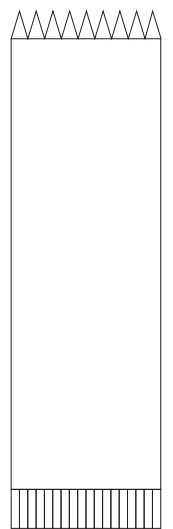

19

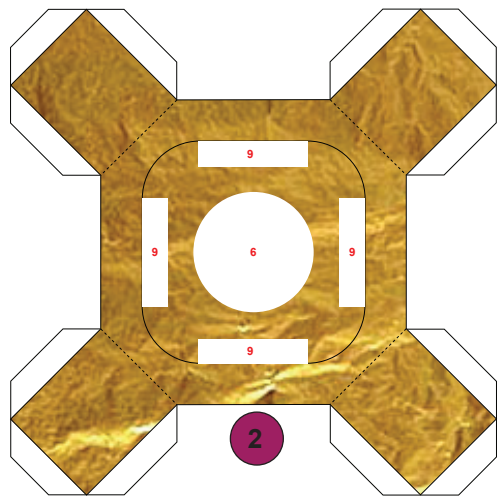

2

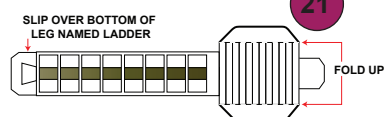

SLIP OVER BOTTOM OF
LEG NAMED LADDER

FOLD UP

21



5

4

7

8

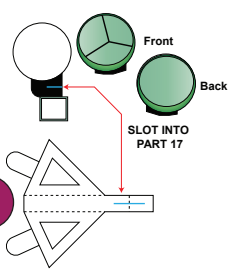

Front

Back

SLOT INTO
PART 17

12

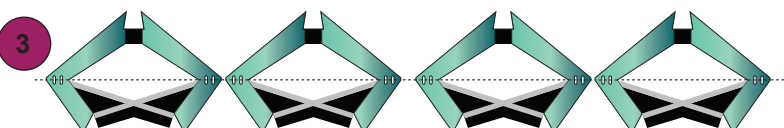

3

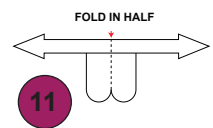

11

FOLD IN HALF

FOLD IN HALF AND CUT OUT CENTRE
ATTACH TO PART 3 AS INDICATED

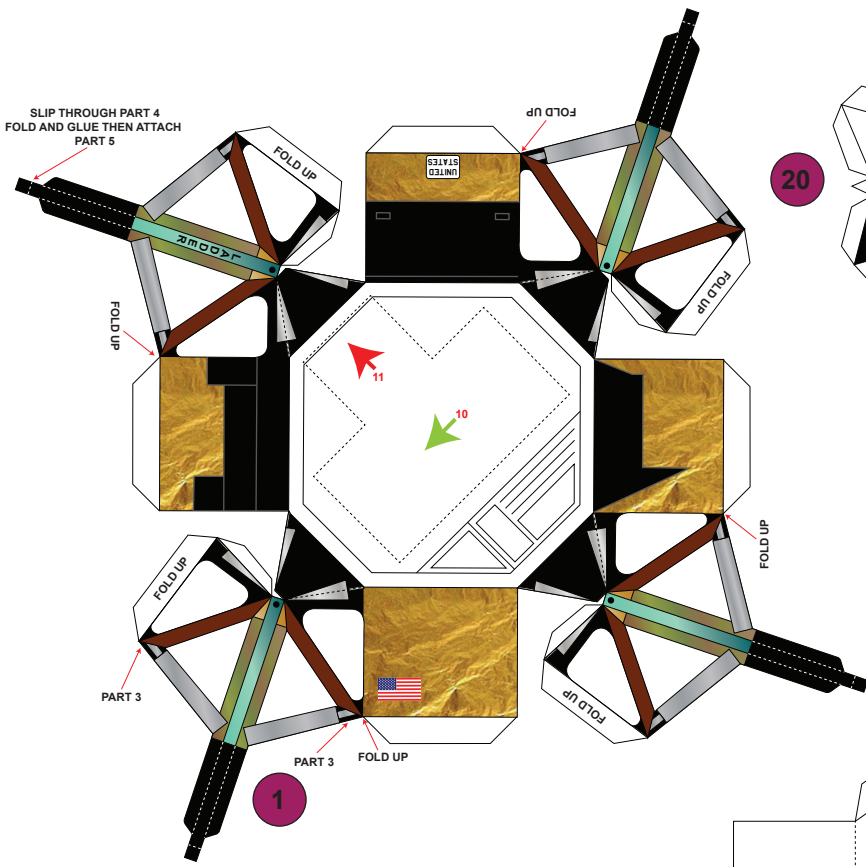

20

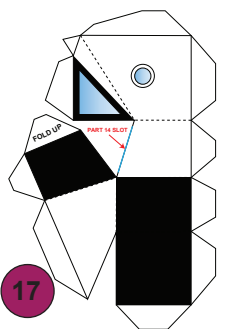
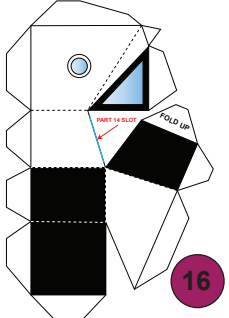
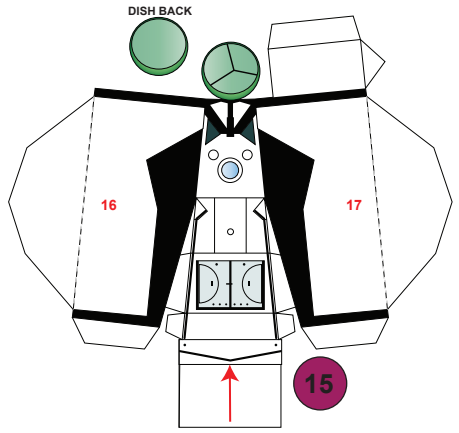
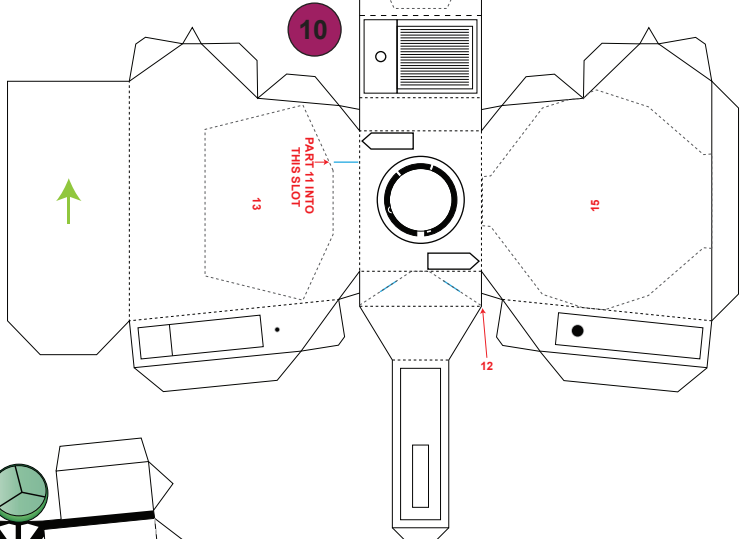
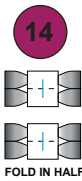
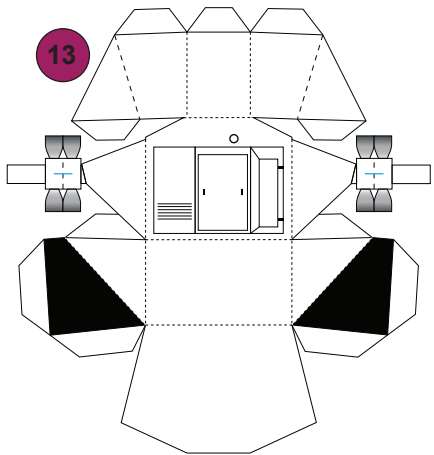
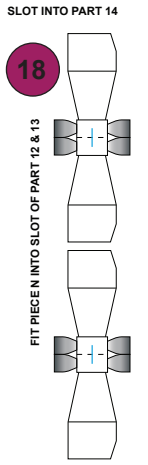
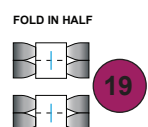
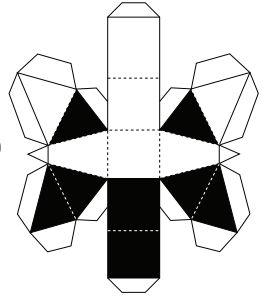

PRINT ON STICKER & ATTACH TO
3MM FOAM BOARD

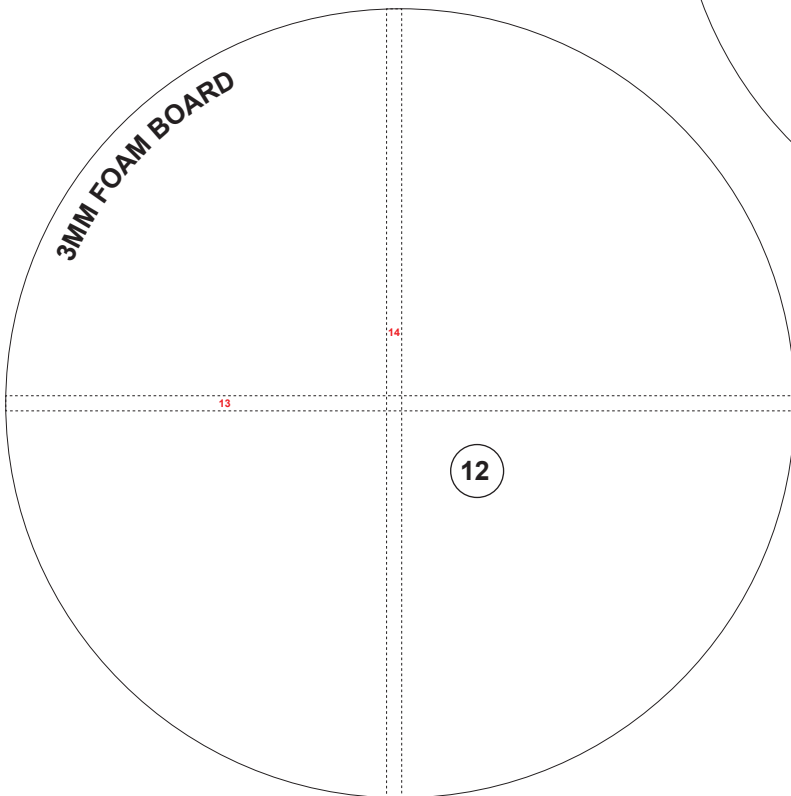
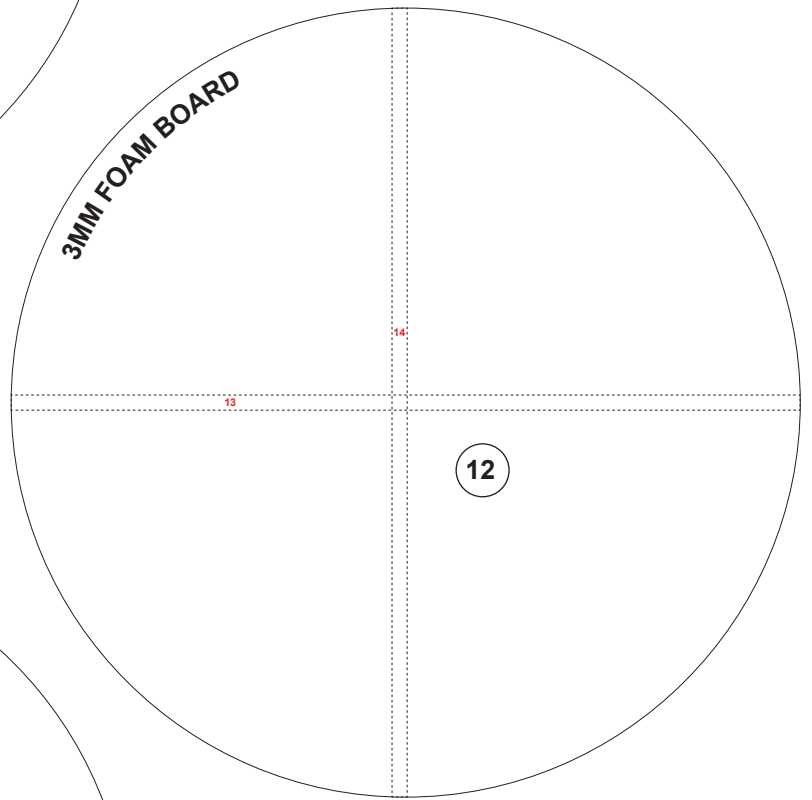
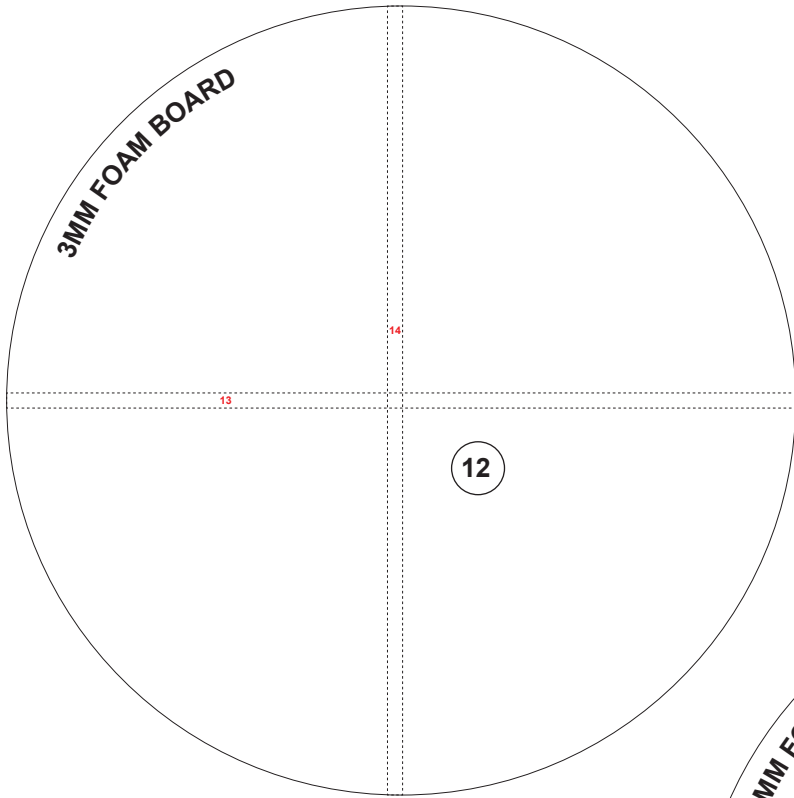

PRINT ON STICKER & ATTACH TO
3MM FOAM BOARD

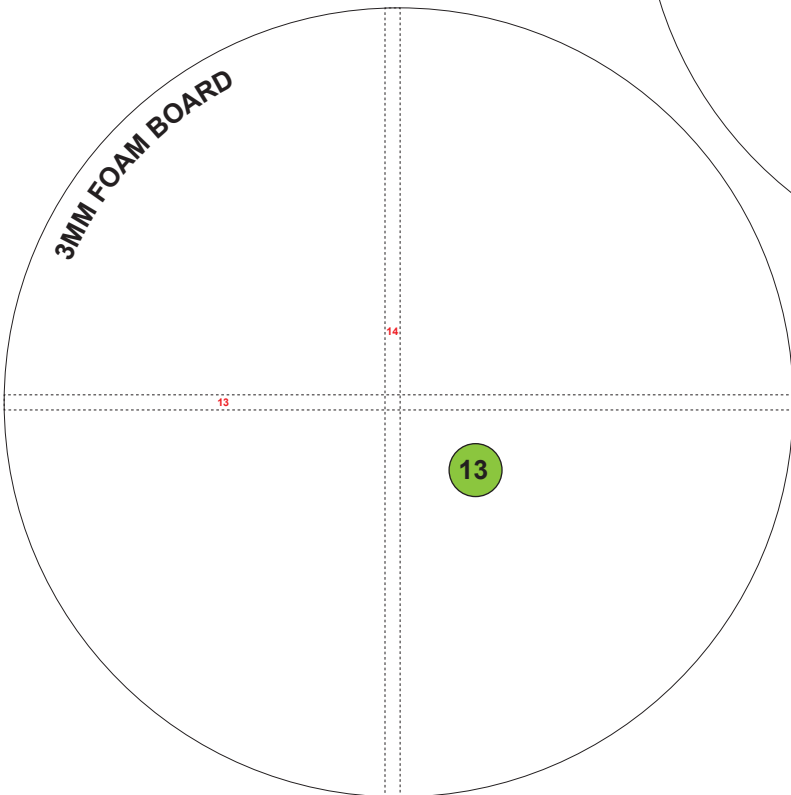
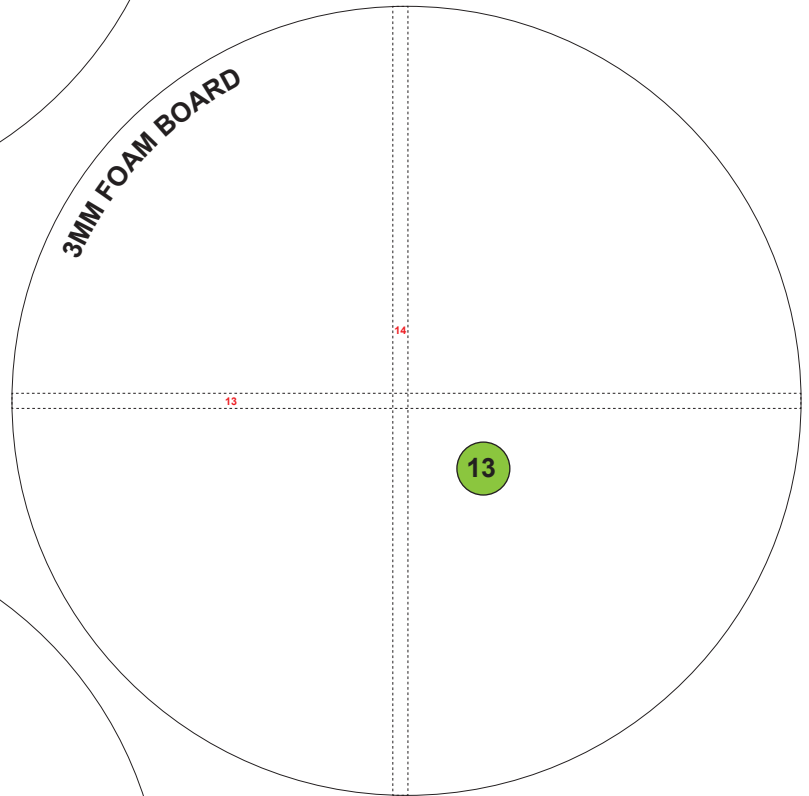
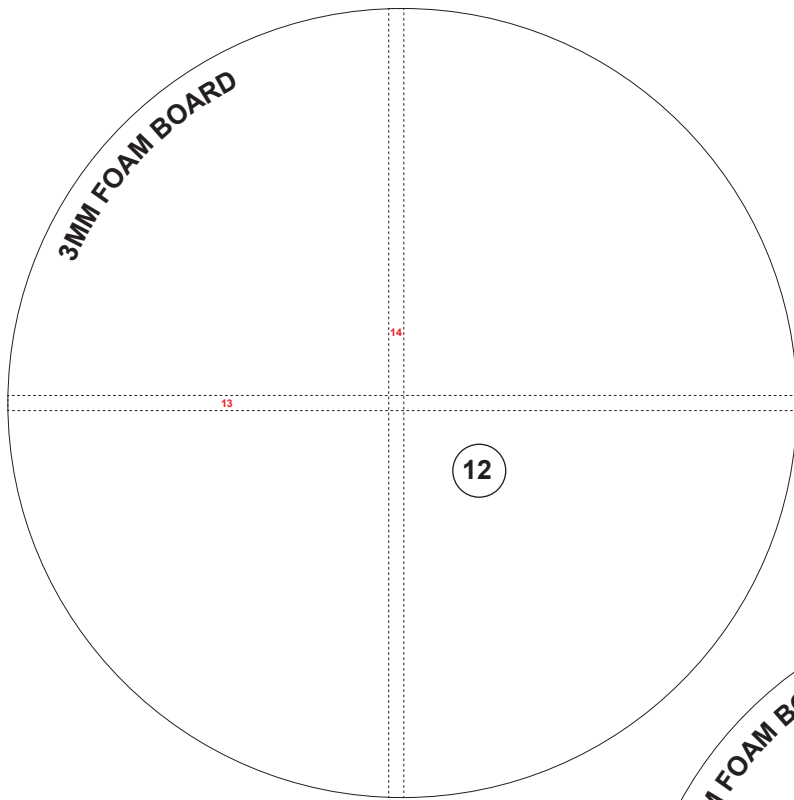

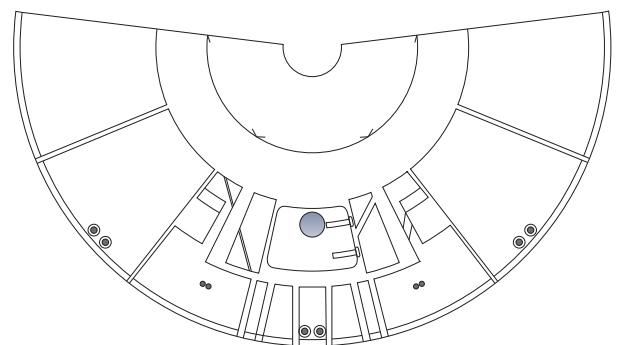
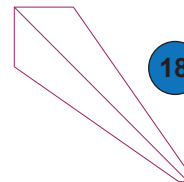
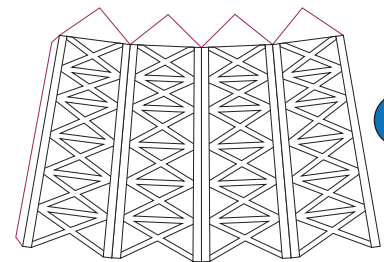
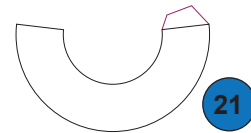
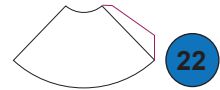
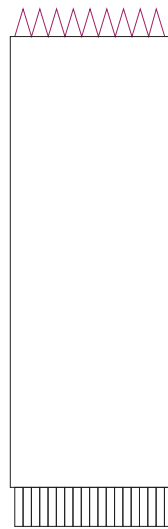
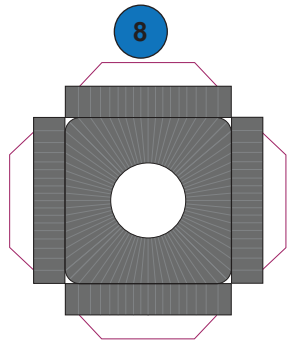
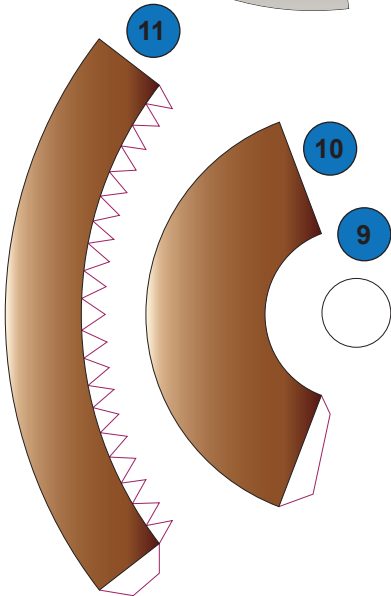
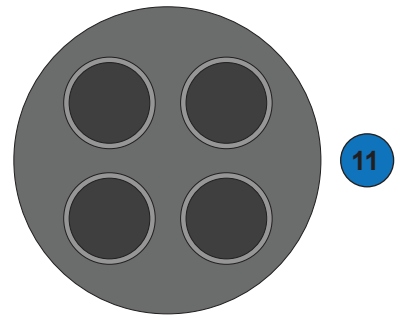
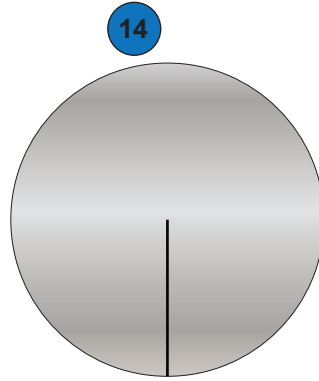
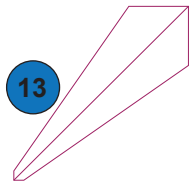
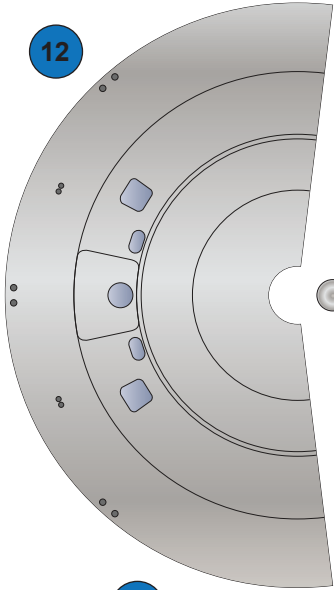
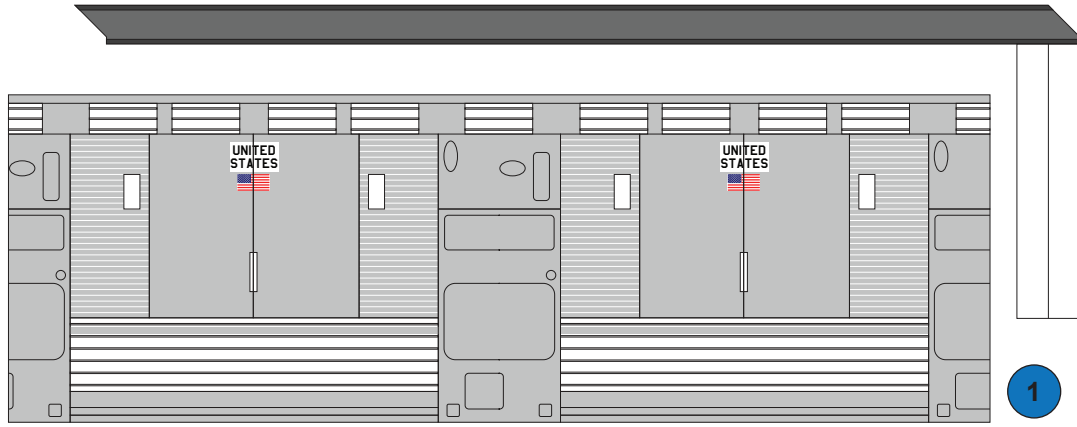



PRINT ON STICKER & ATTACH TO
3MM FOAM BOARD

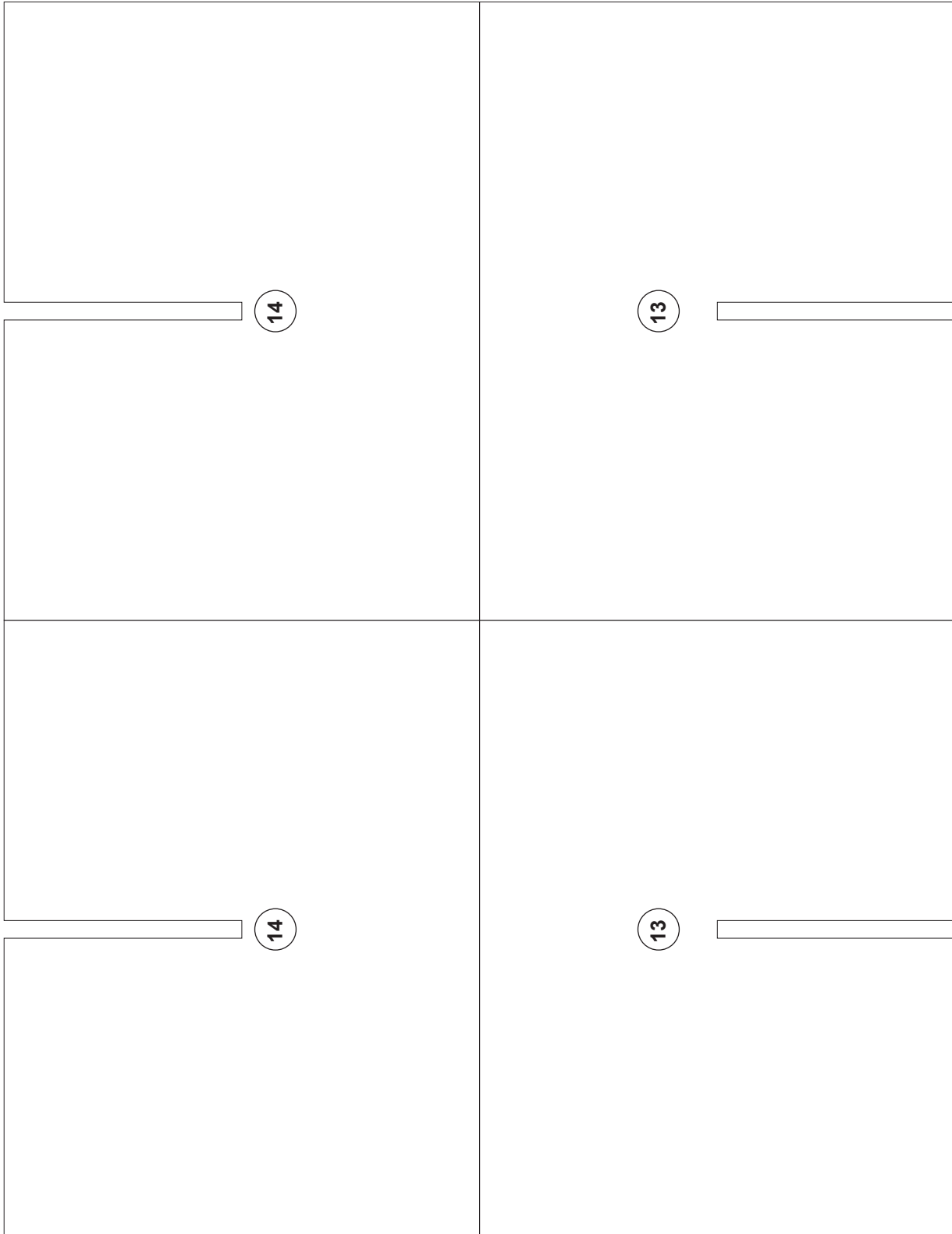

PRINT ON STICKER & ATTACH TO
3MM FOAM BOARD

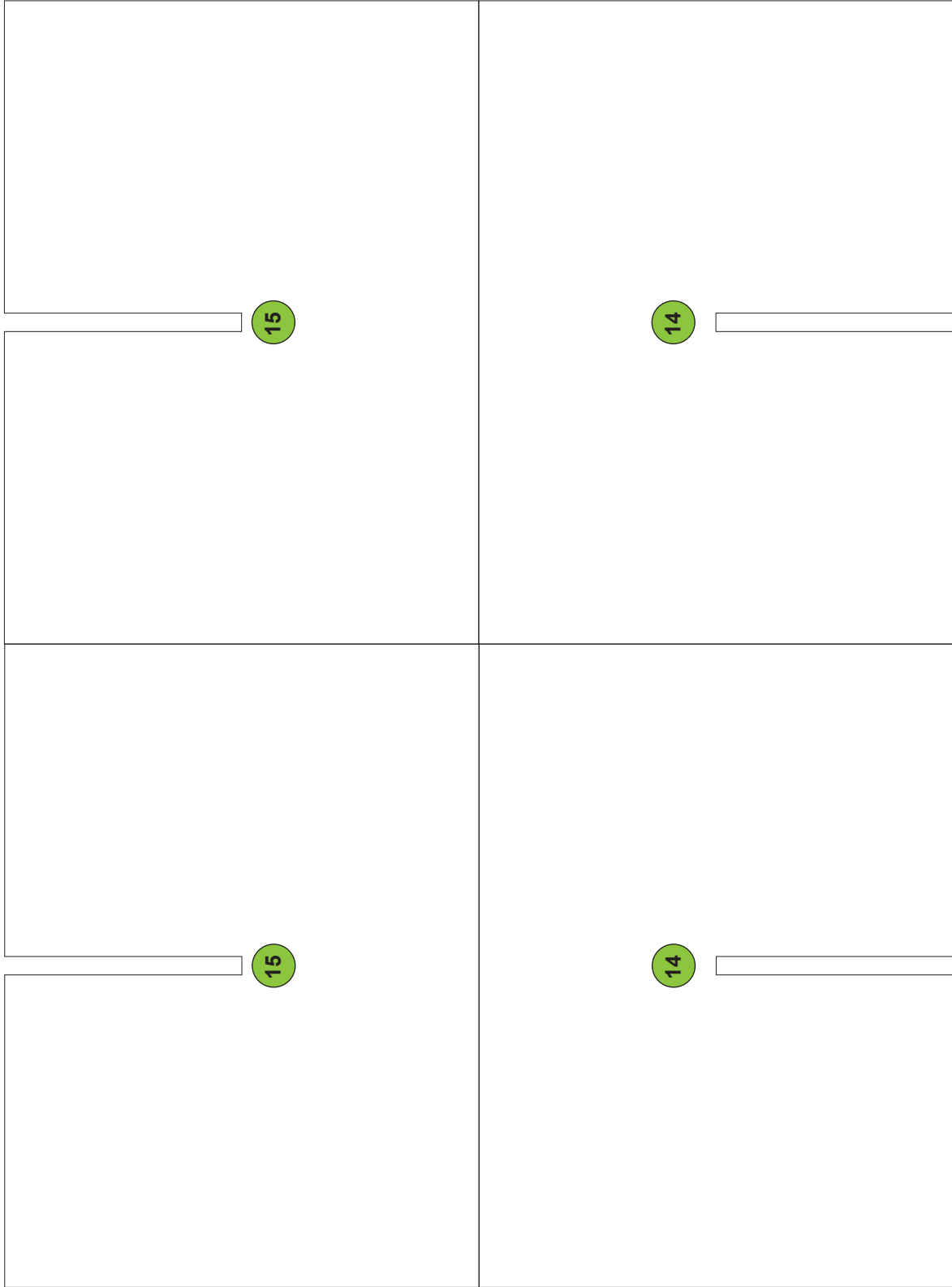

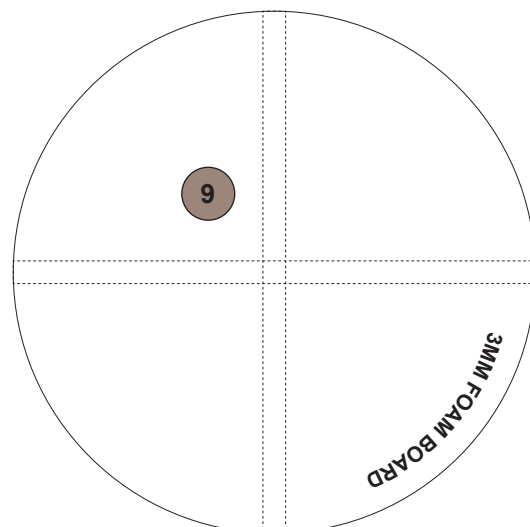
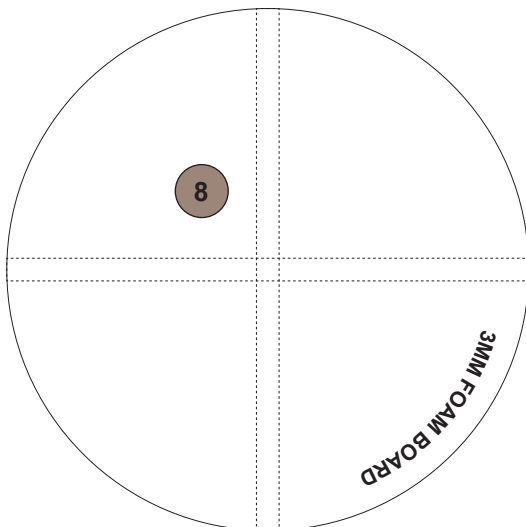
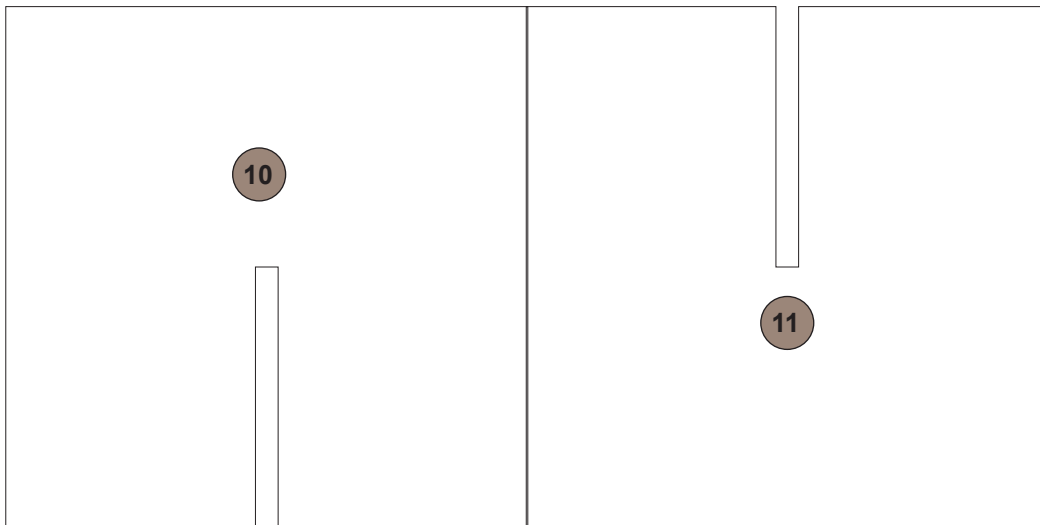
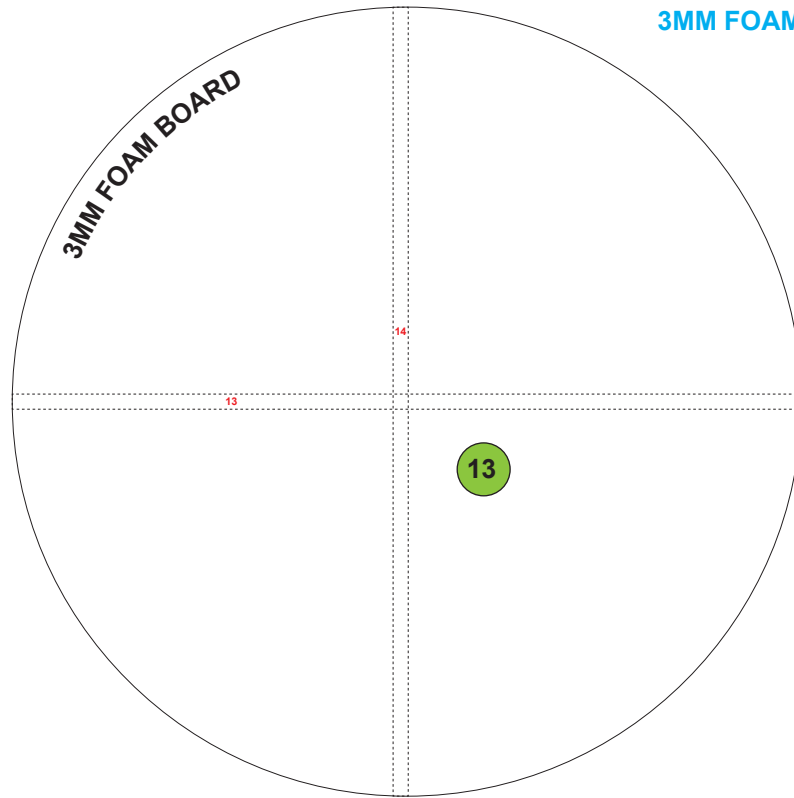

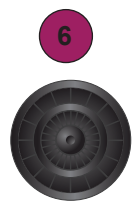
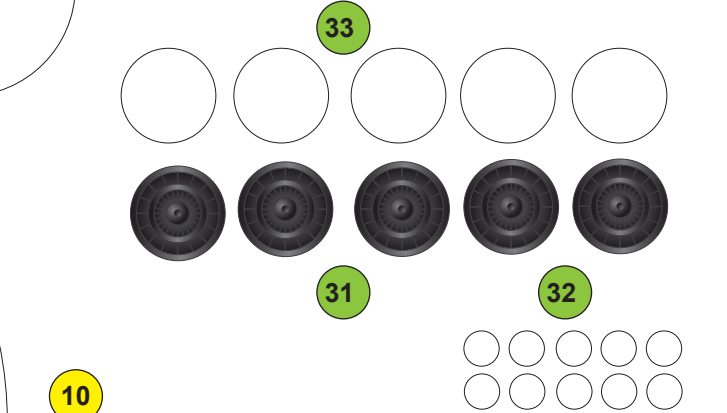
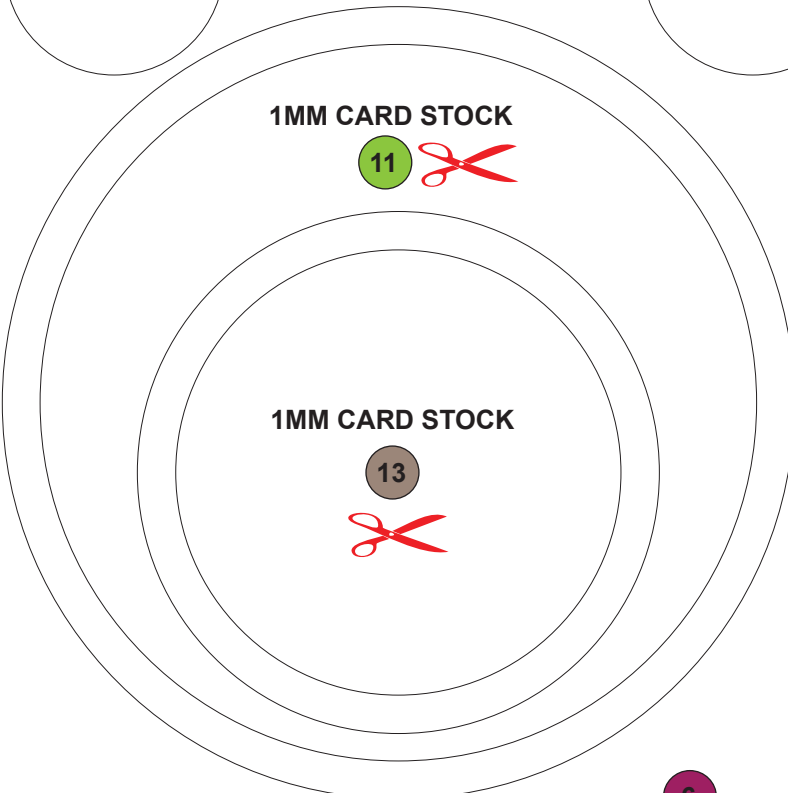
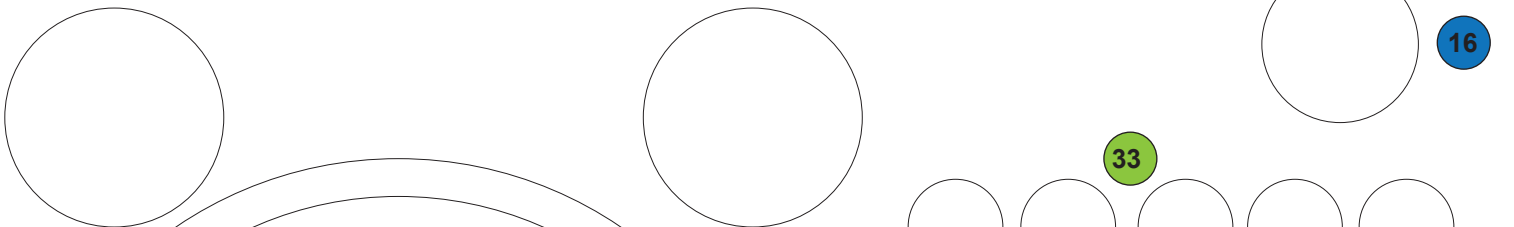
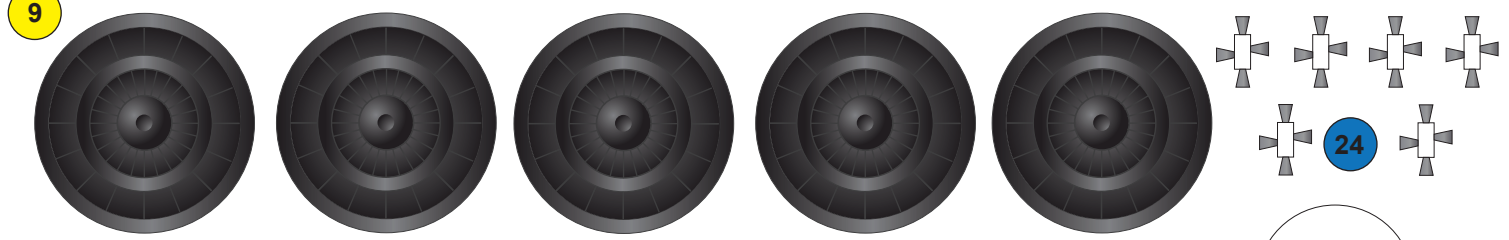
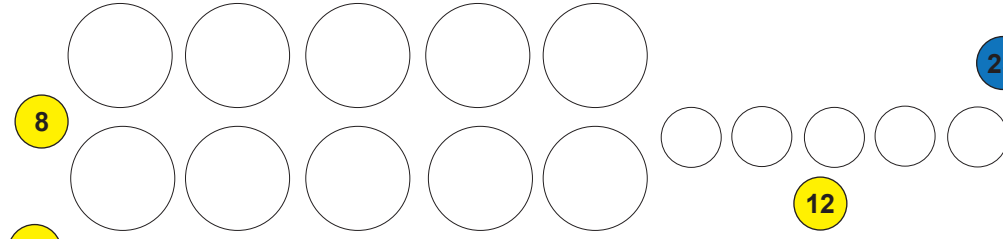
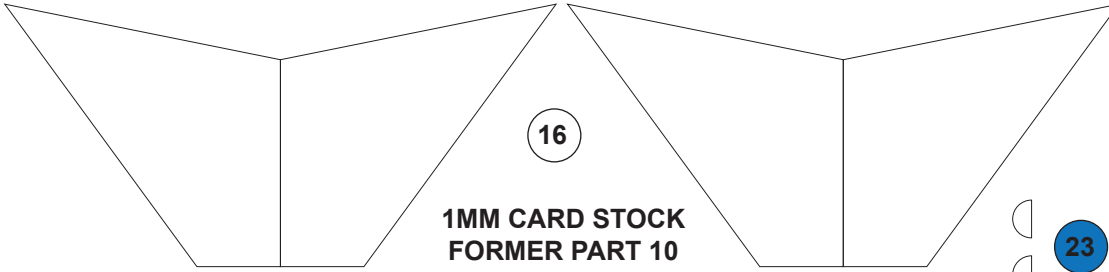

1mm Card Stock

PRINT ON STICKER & ATTACH TO
2MM CARD STOCK

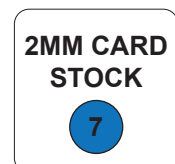
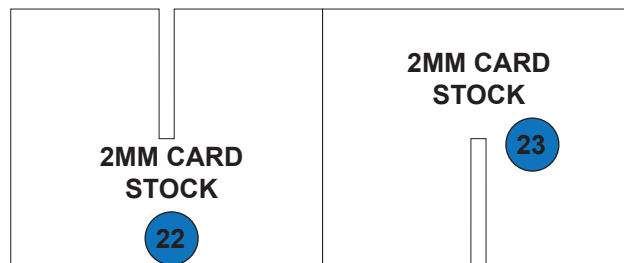
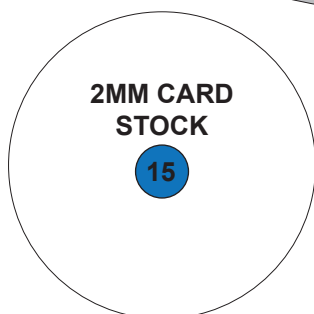
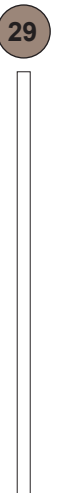
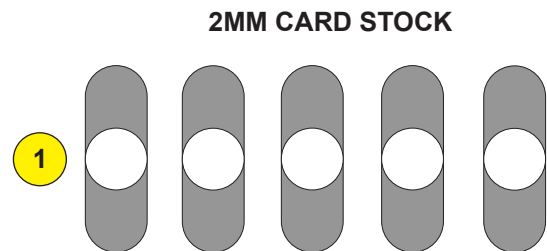
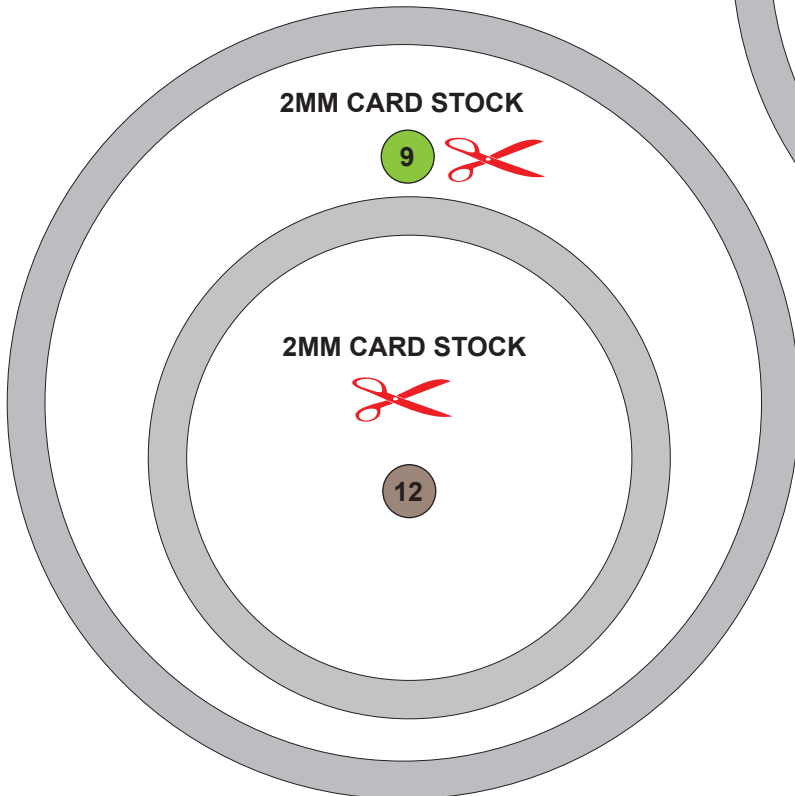
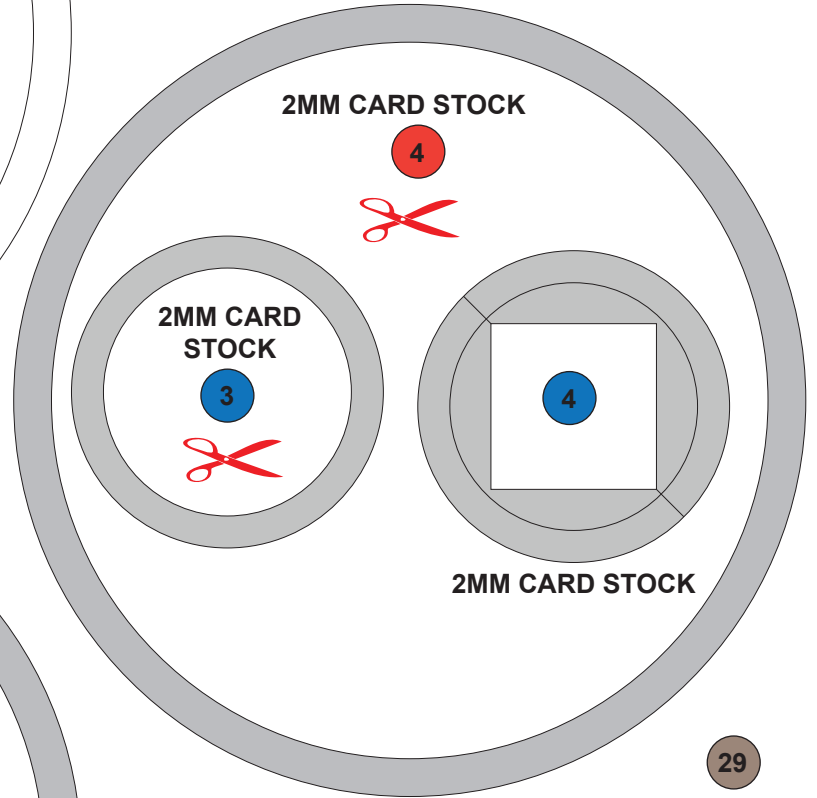
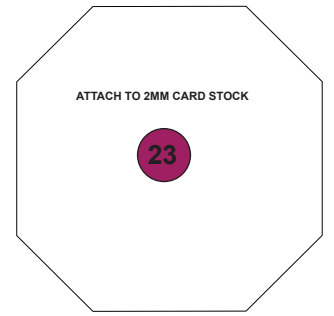
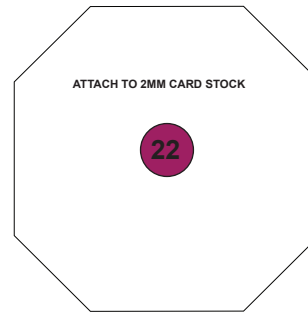
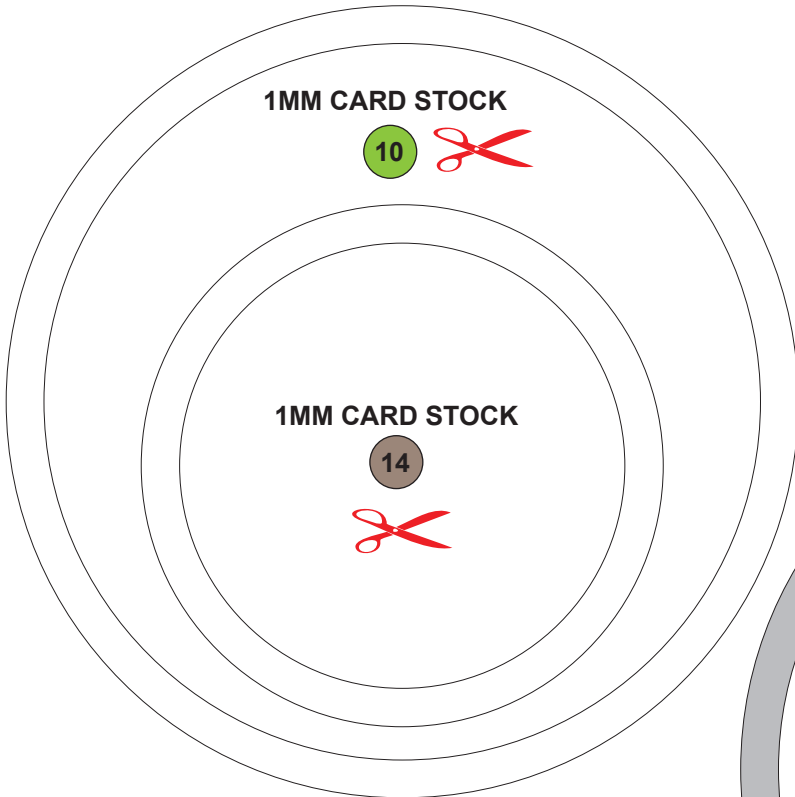

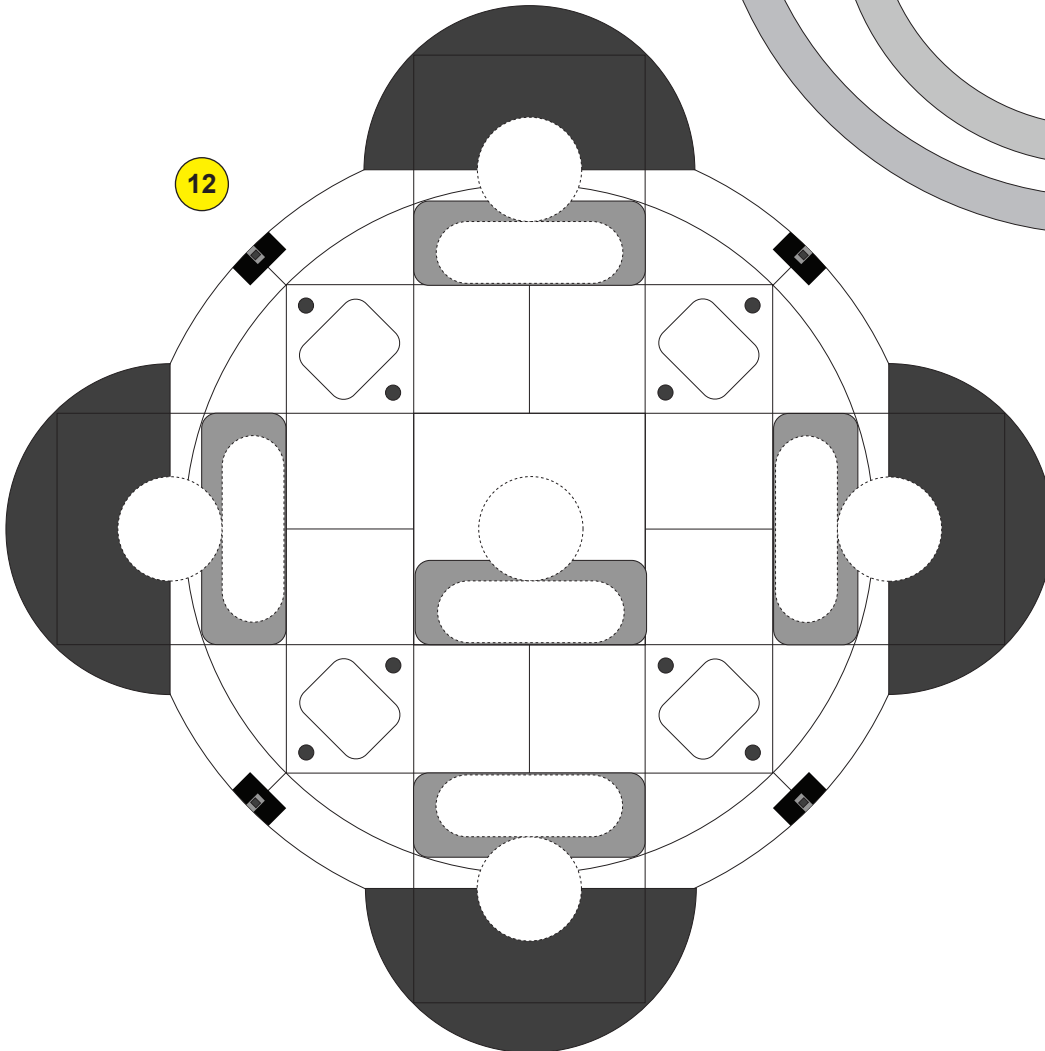
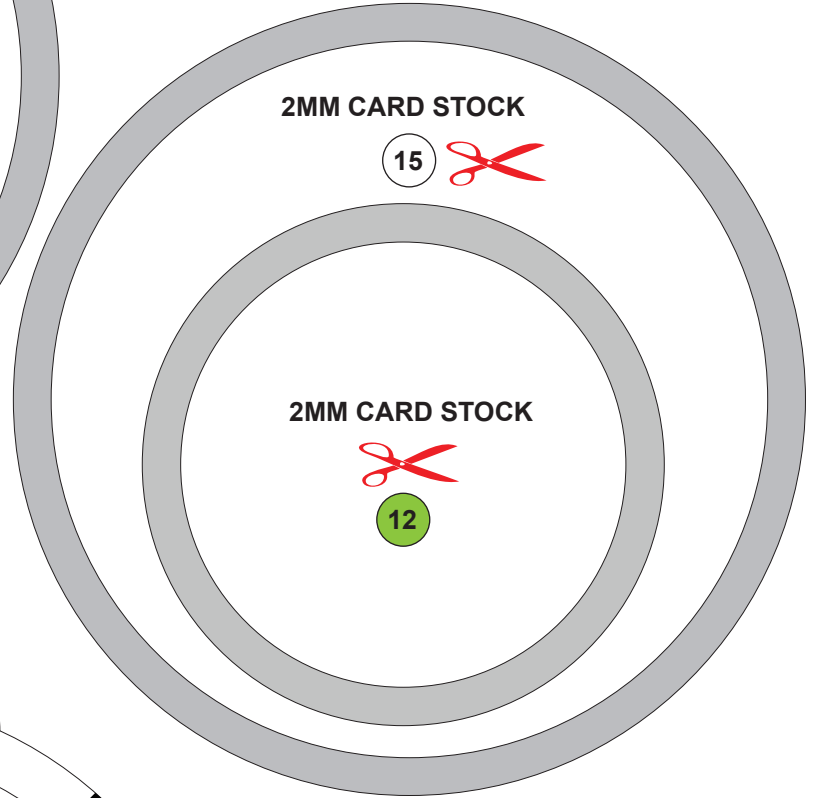
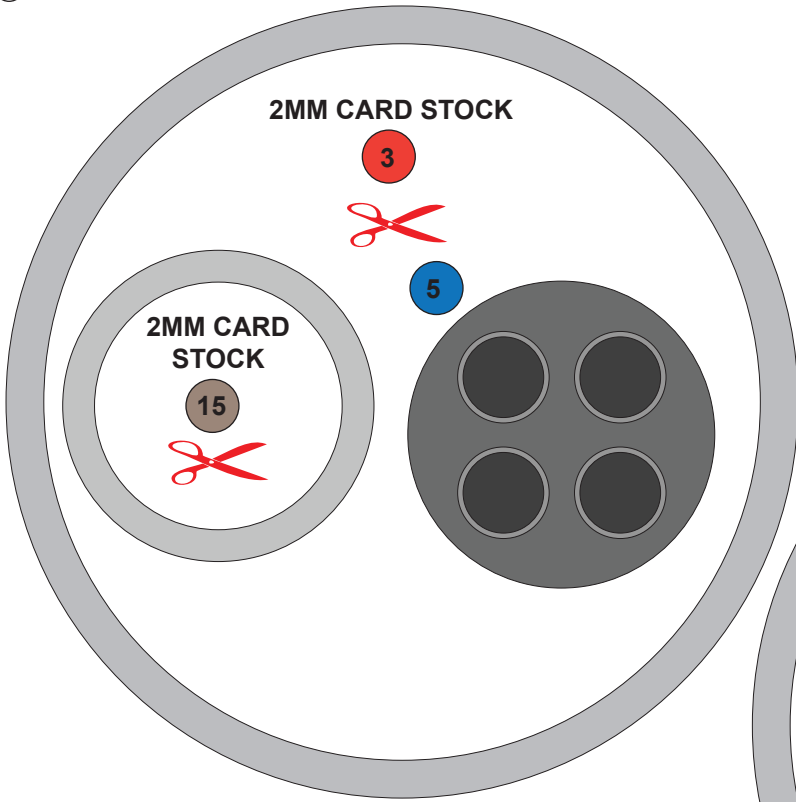

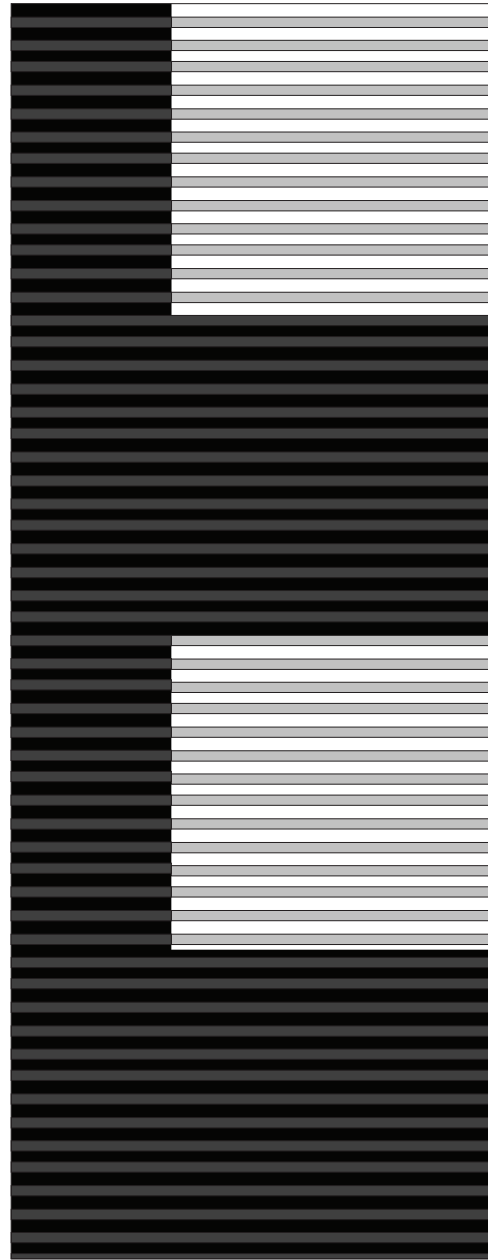
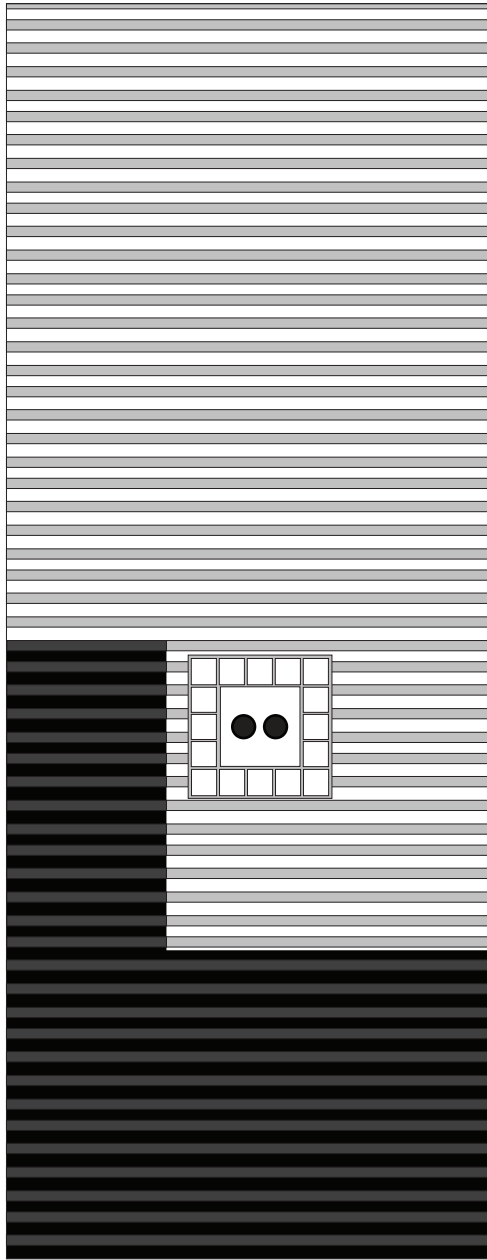

B1

B2

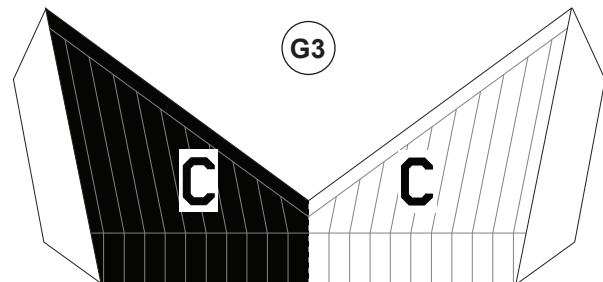
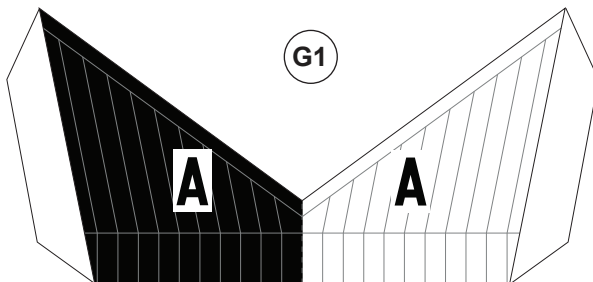
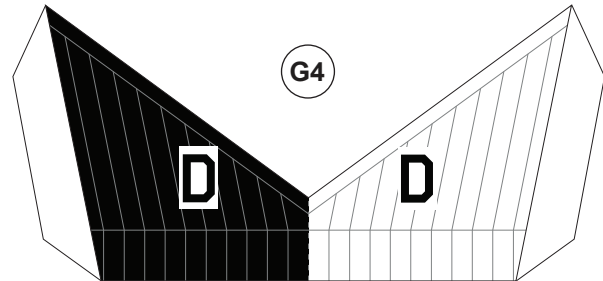
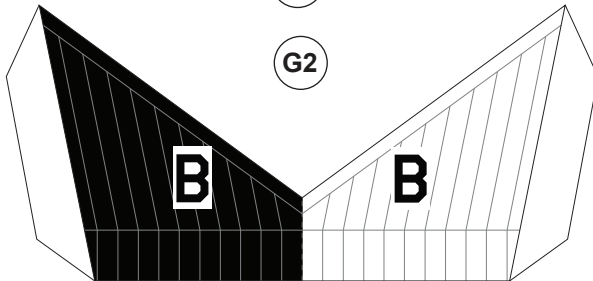

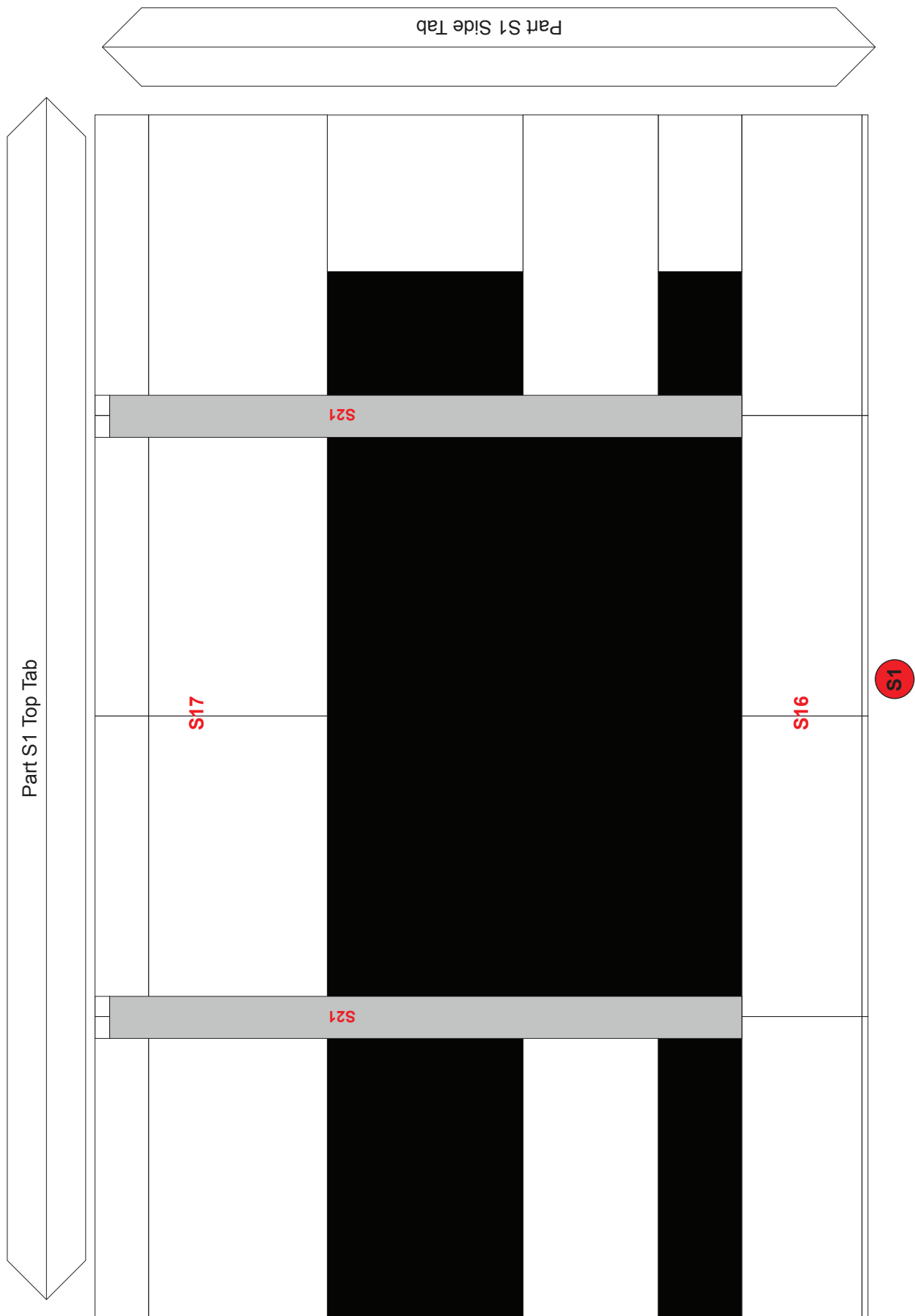



S10

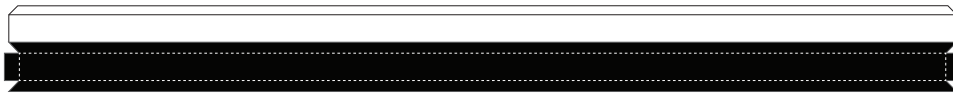

S18

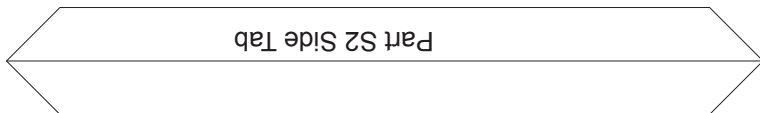

Part S2 Side Tab



Part S2 Top Tab

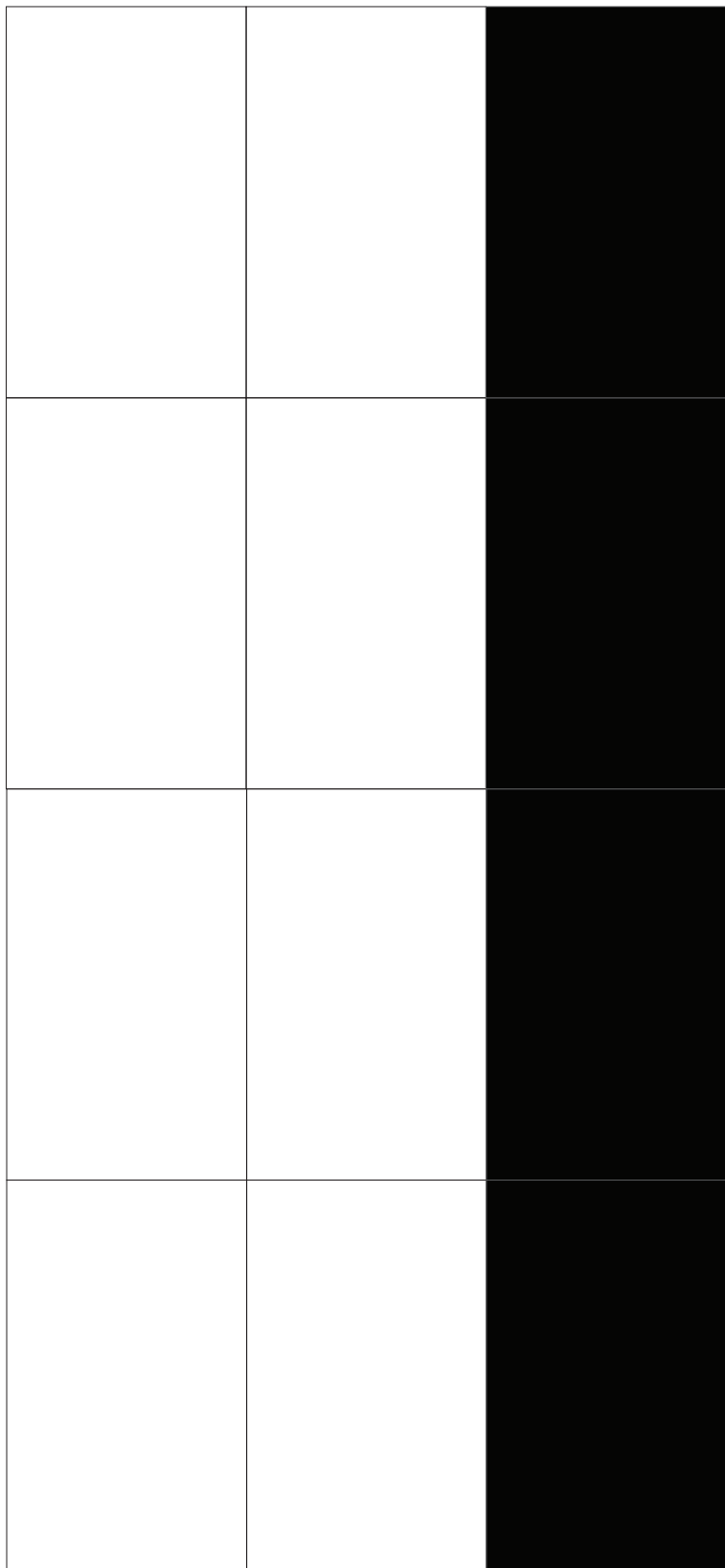

S2

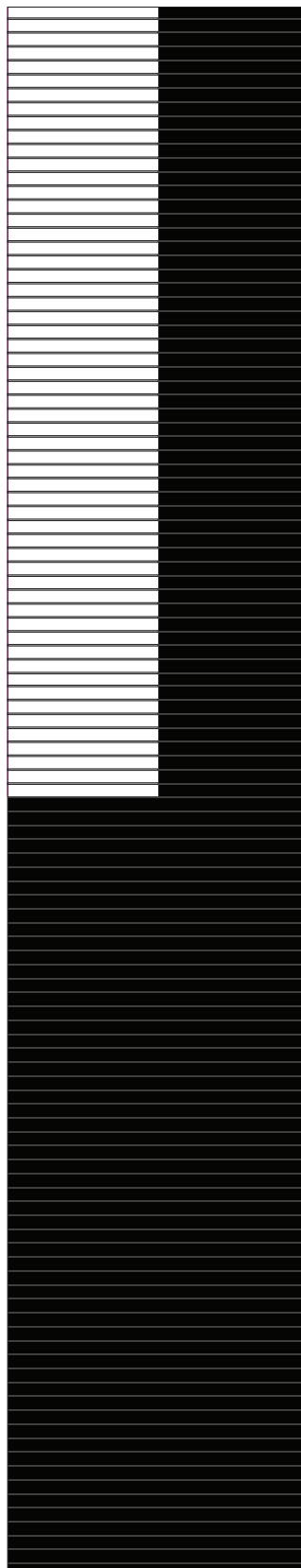

S17

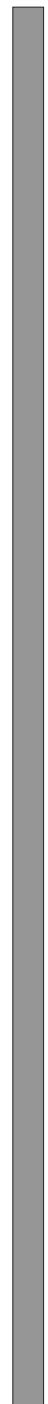

S8

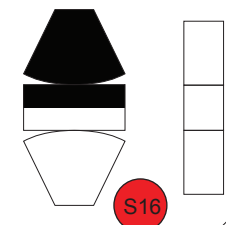

S16

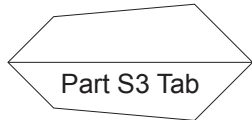

Part S3 Tab

S3

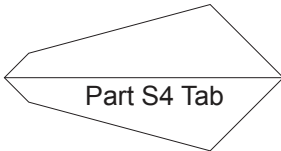

Part S4 Tab

S4

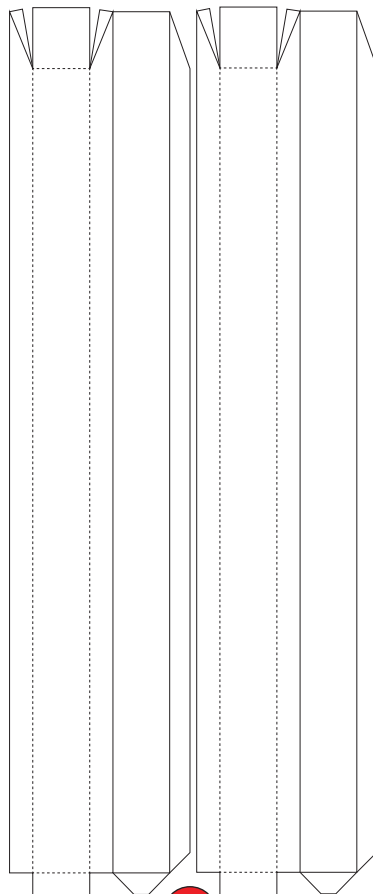

S21

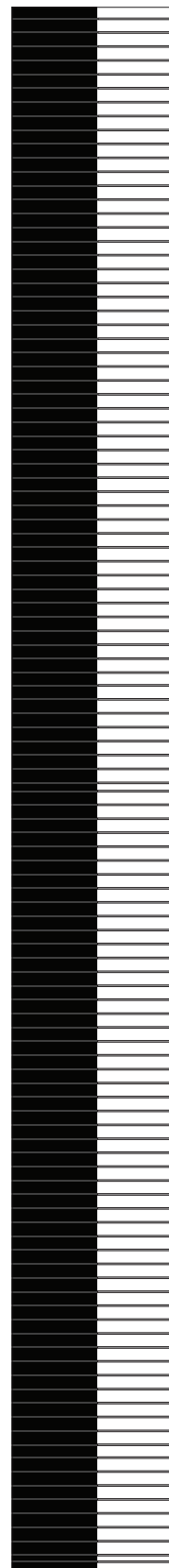

S16

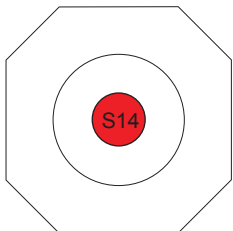
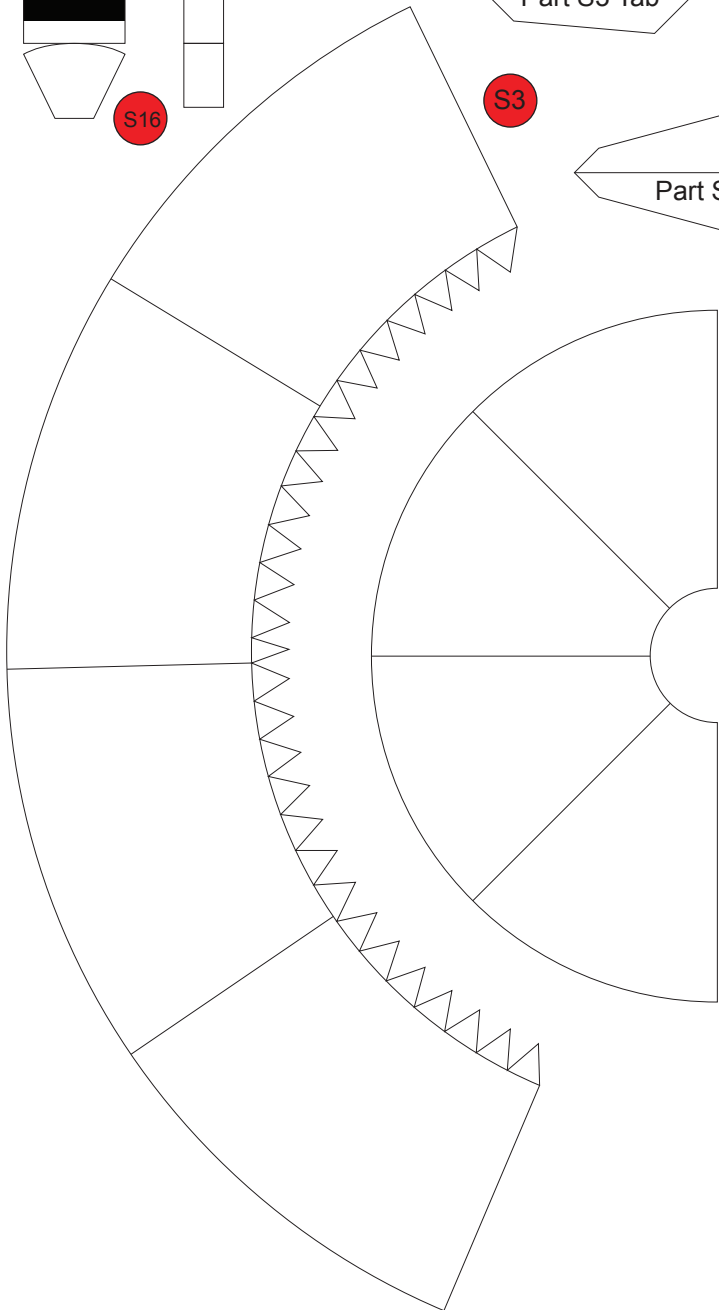

S14

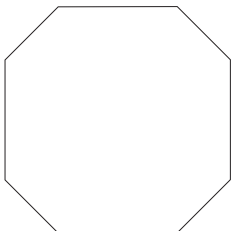

S15

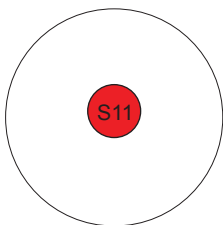

S11

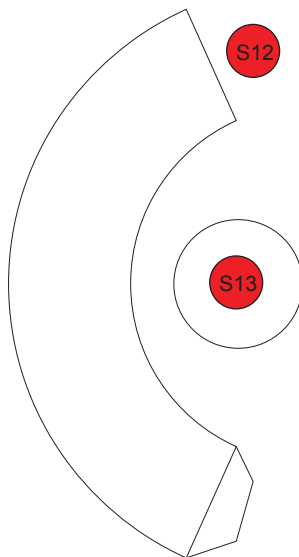

S12

S13

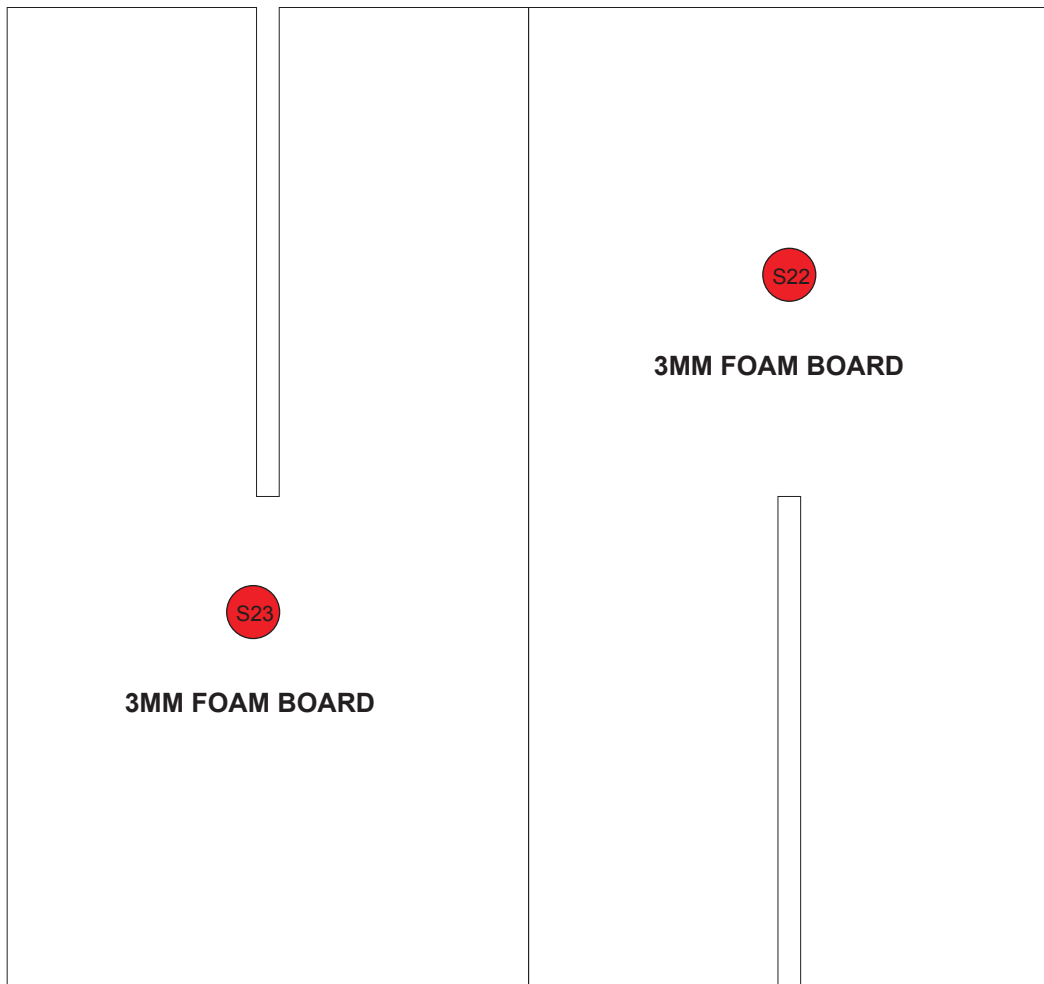
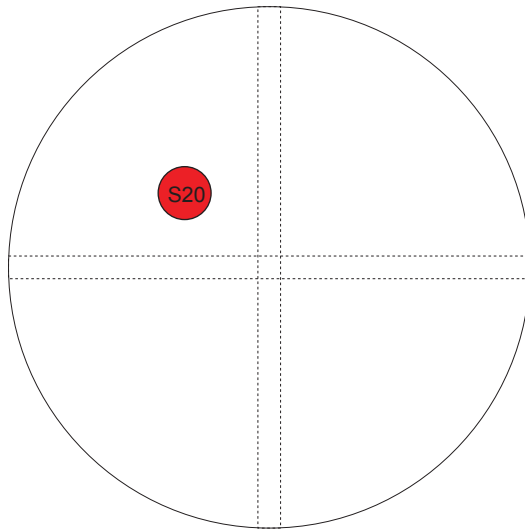
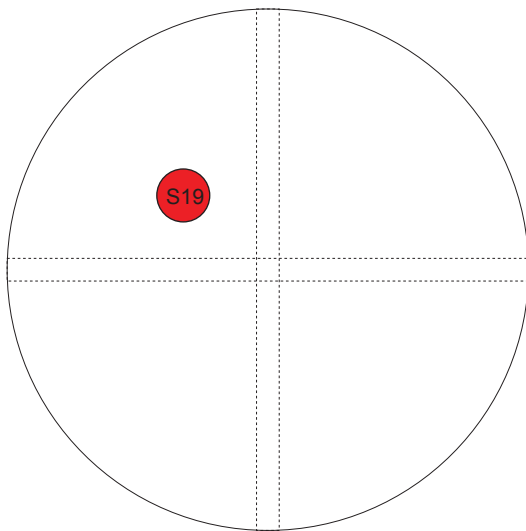

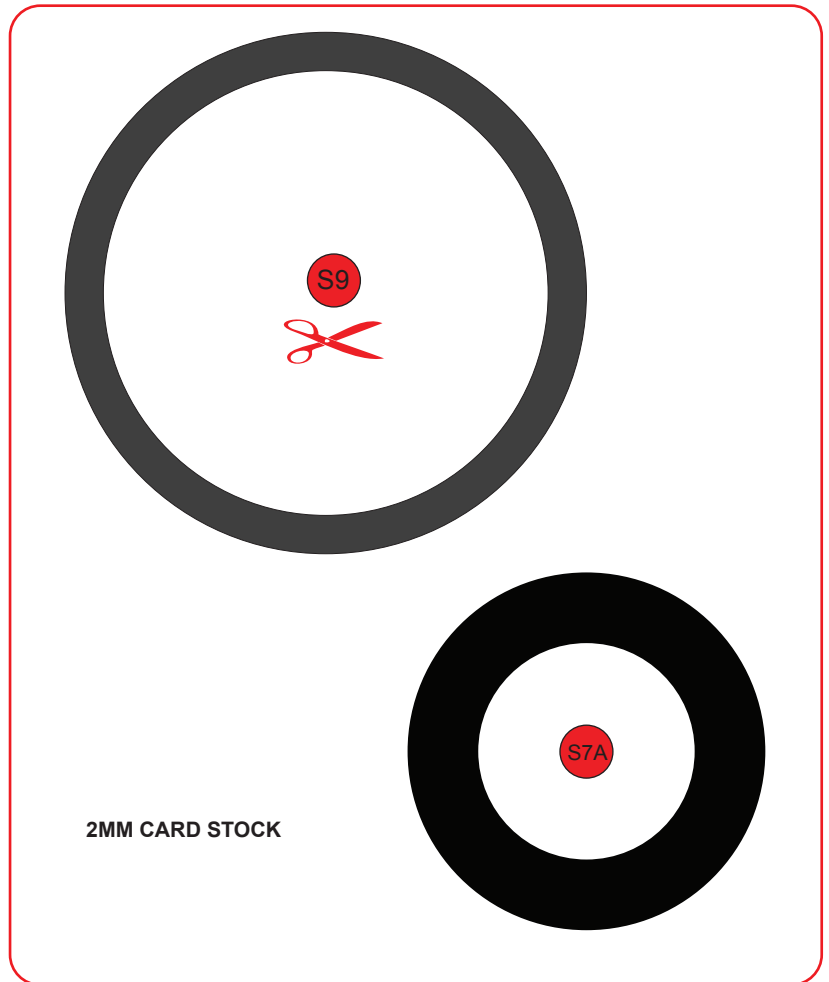
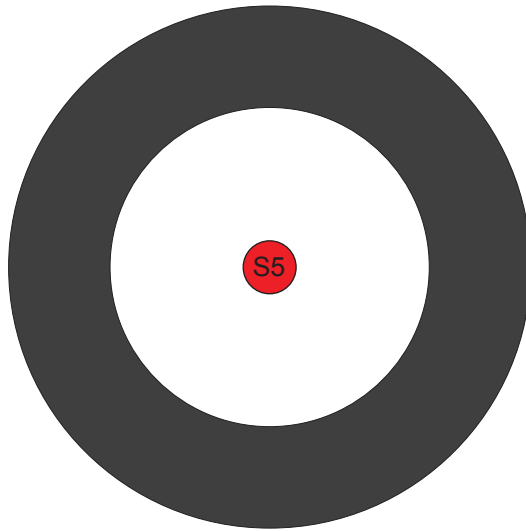
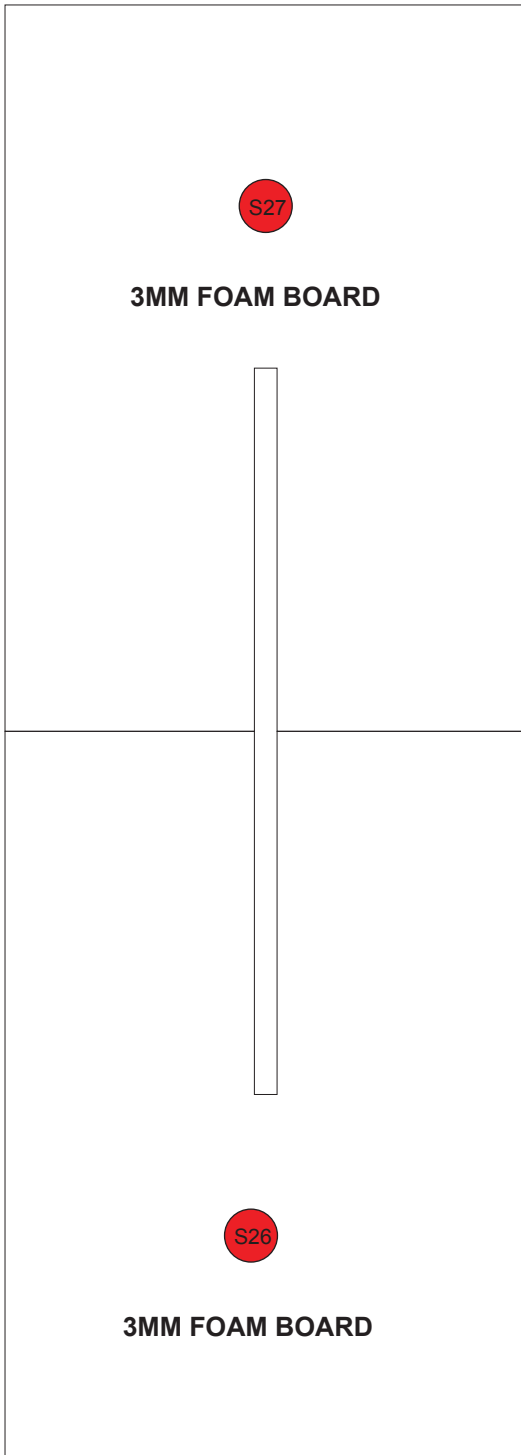

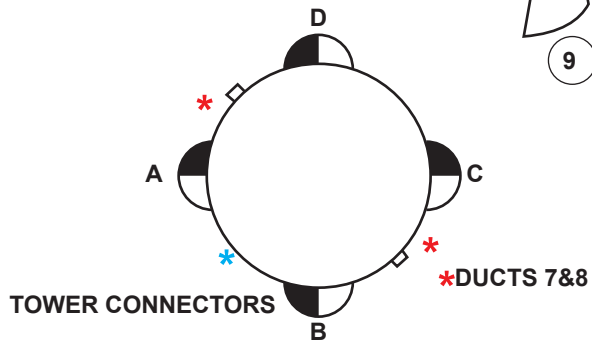
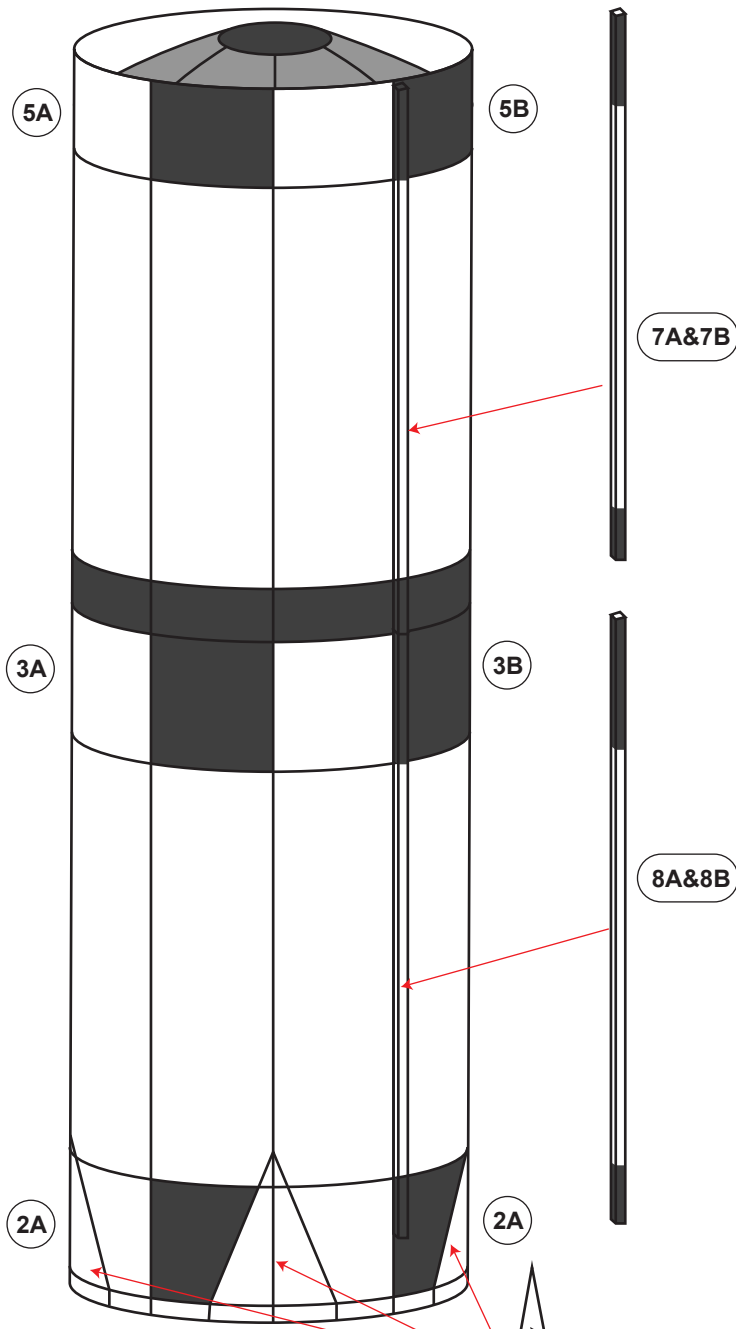
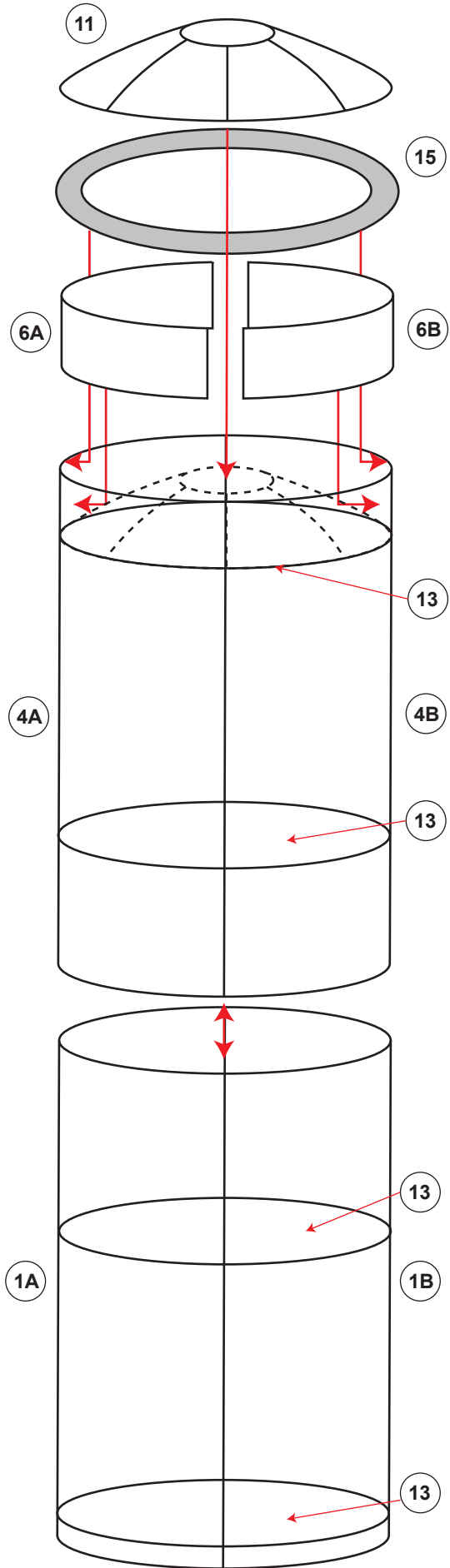



FIRST STAGE ENGINES

SECOND STAGE ENGINES

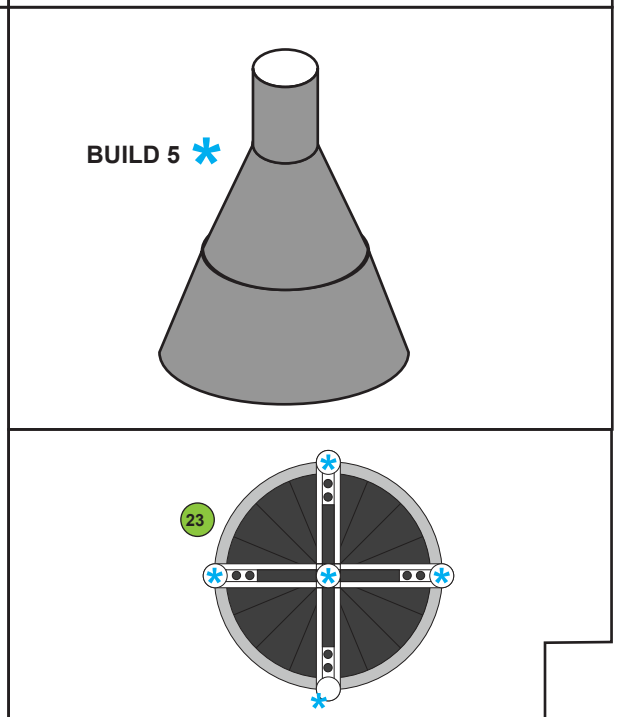
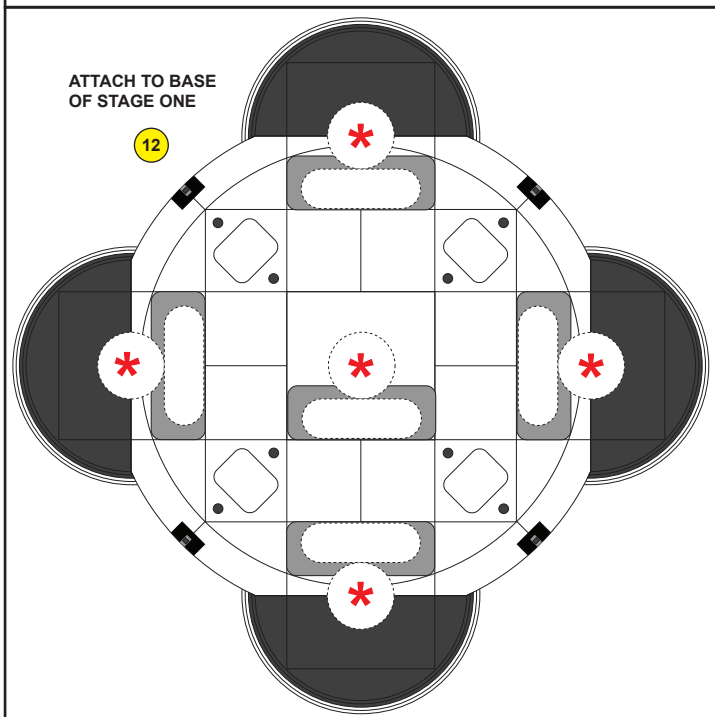
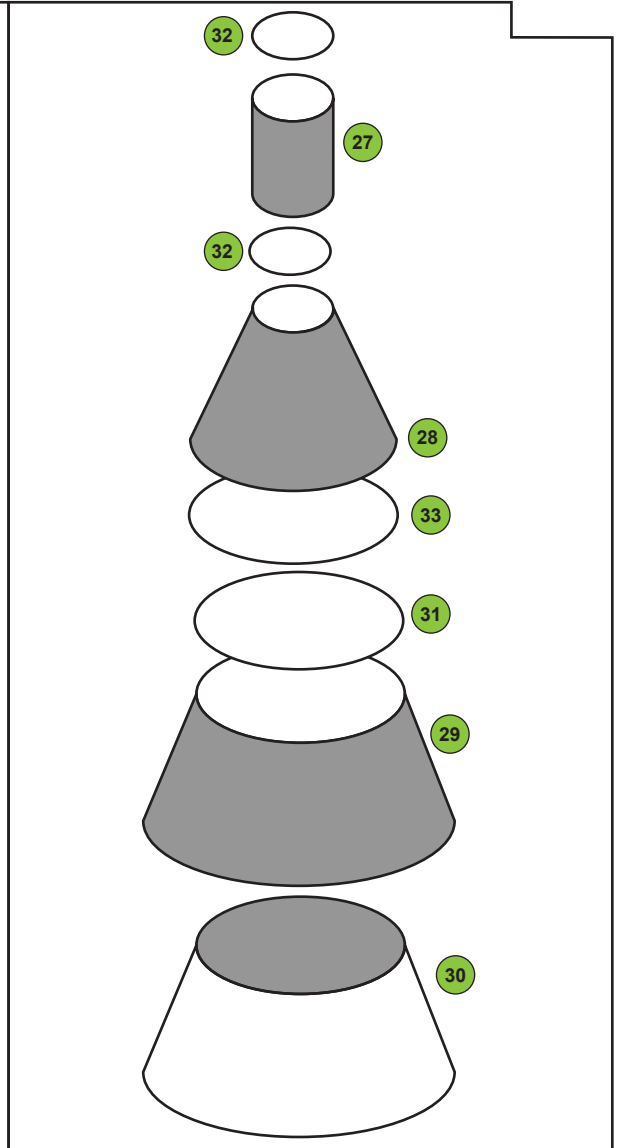
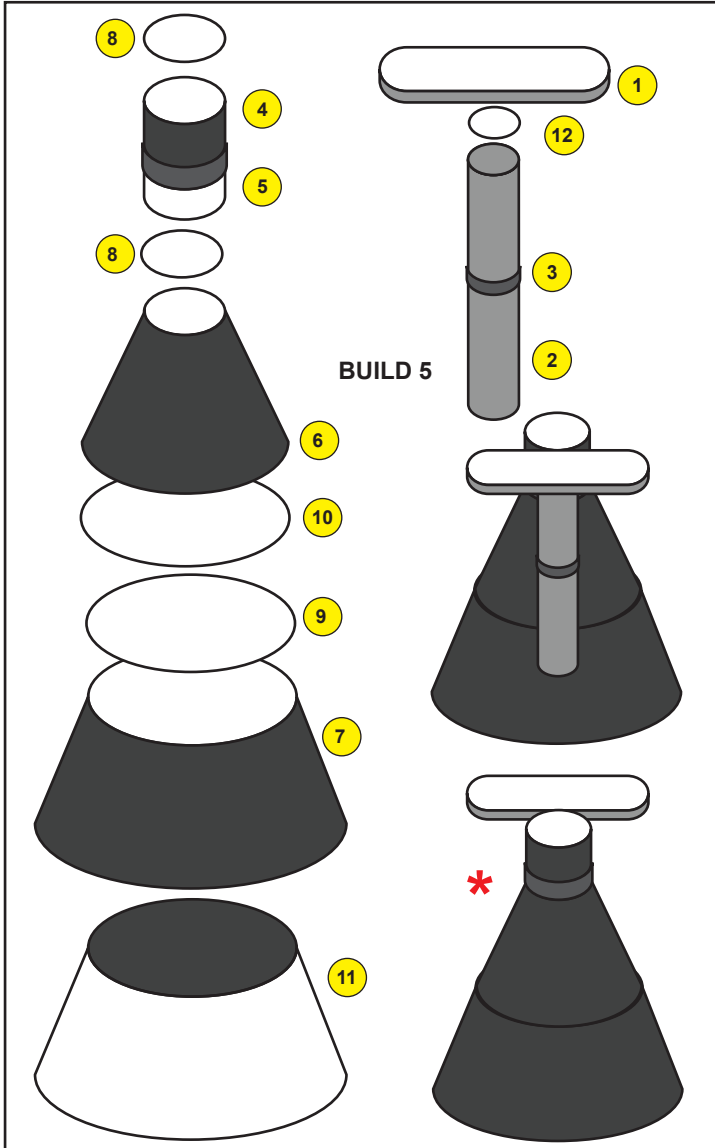



DETAIL PARTS

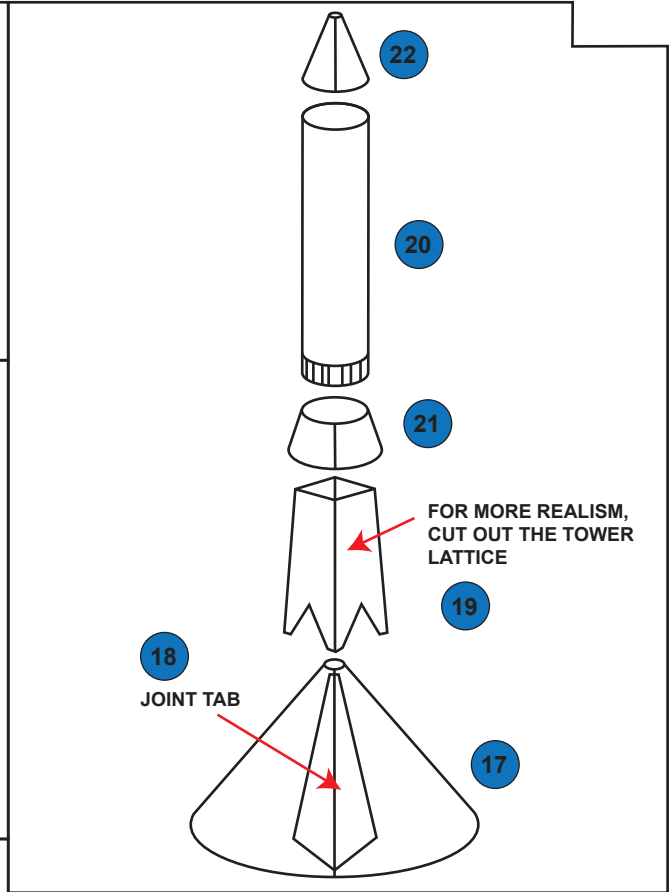
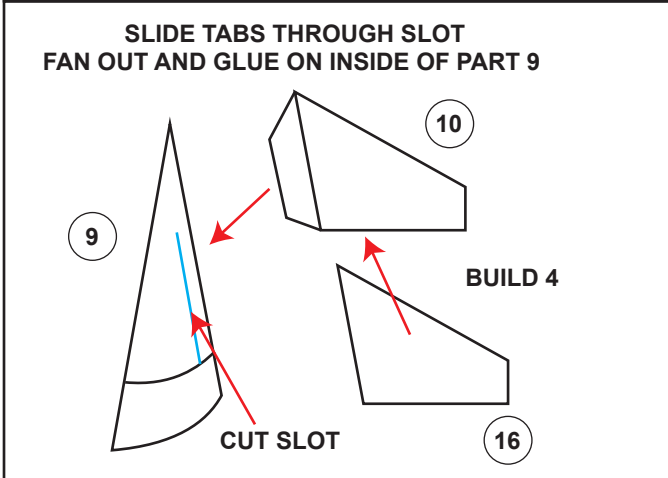
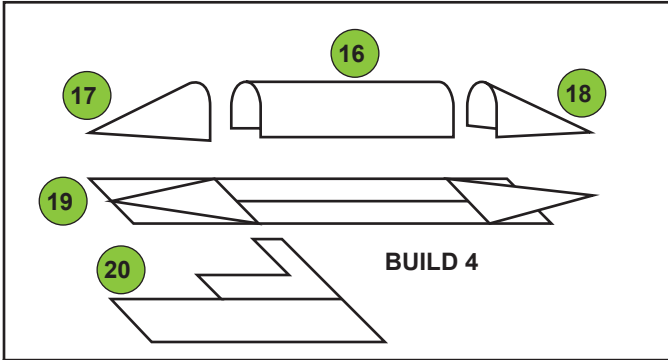

CONNECTOR RING

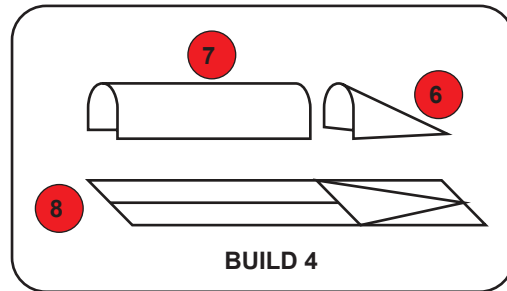
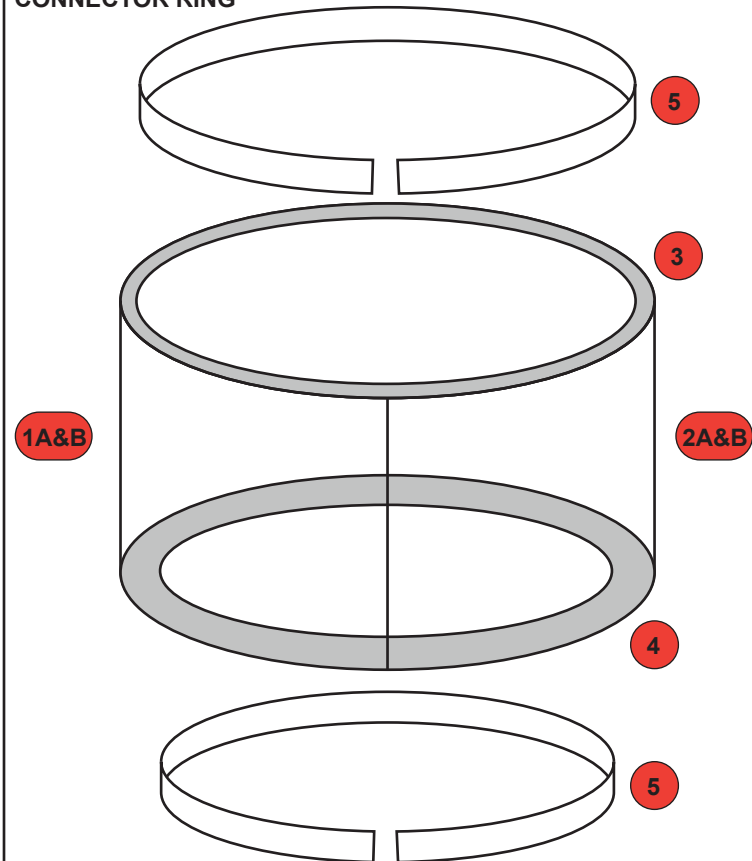

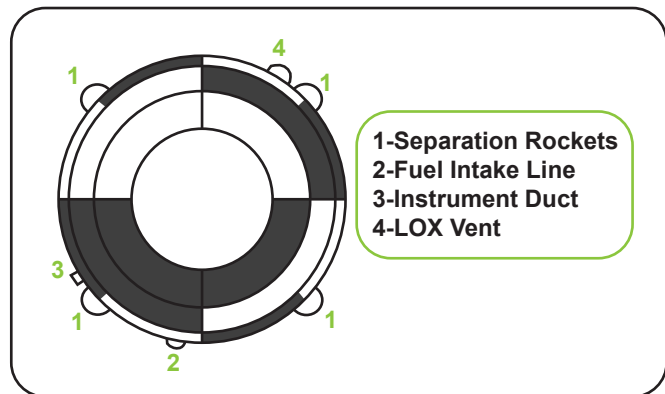
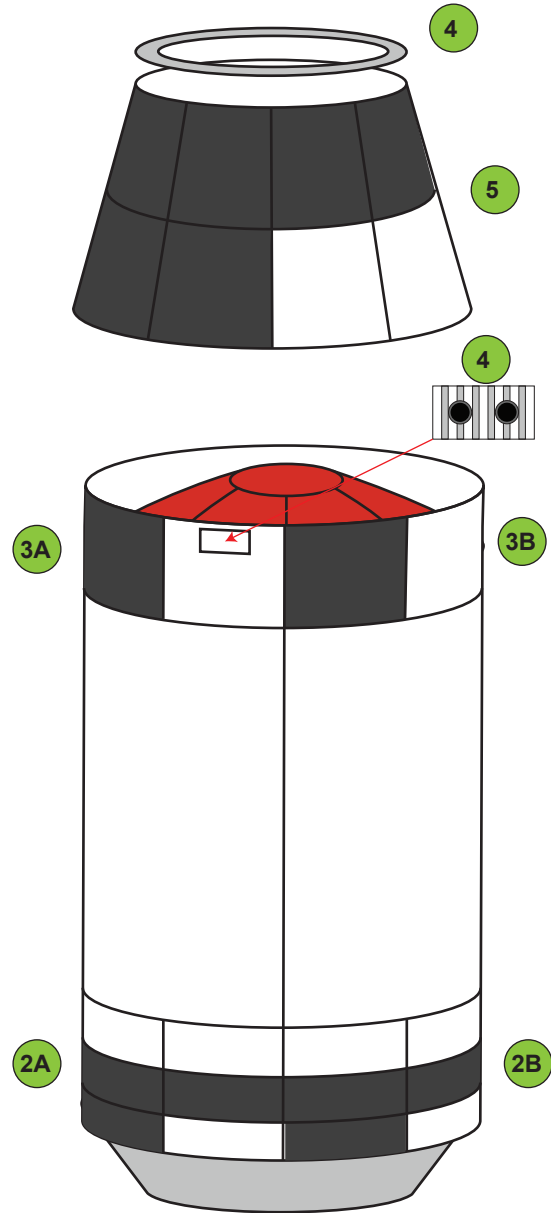
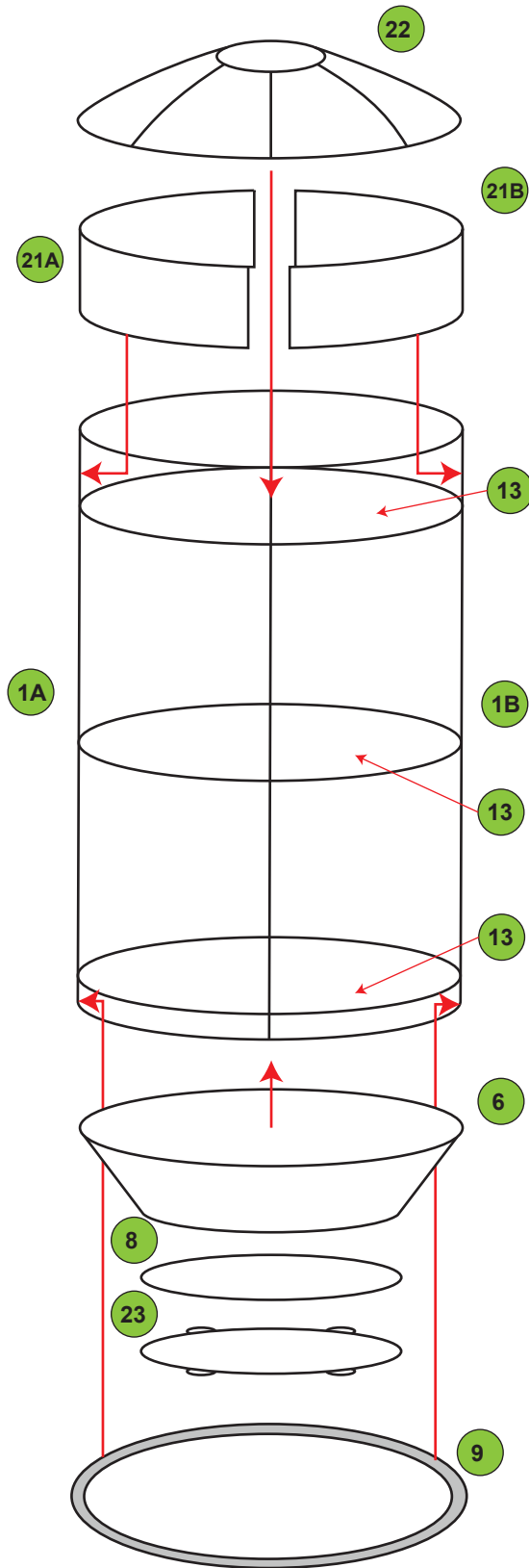



ENGINE

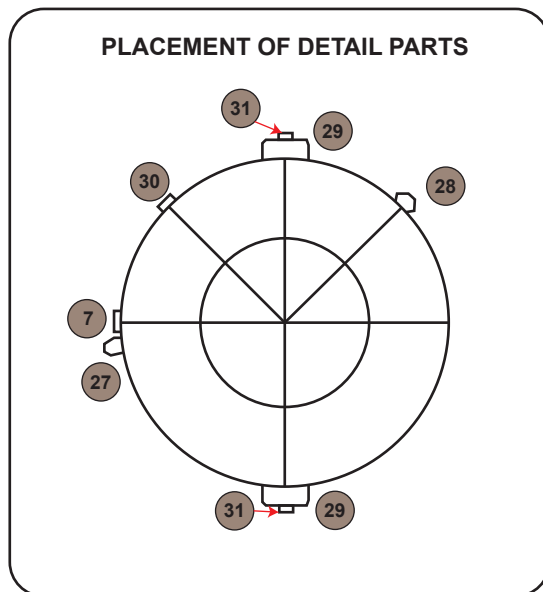
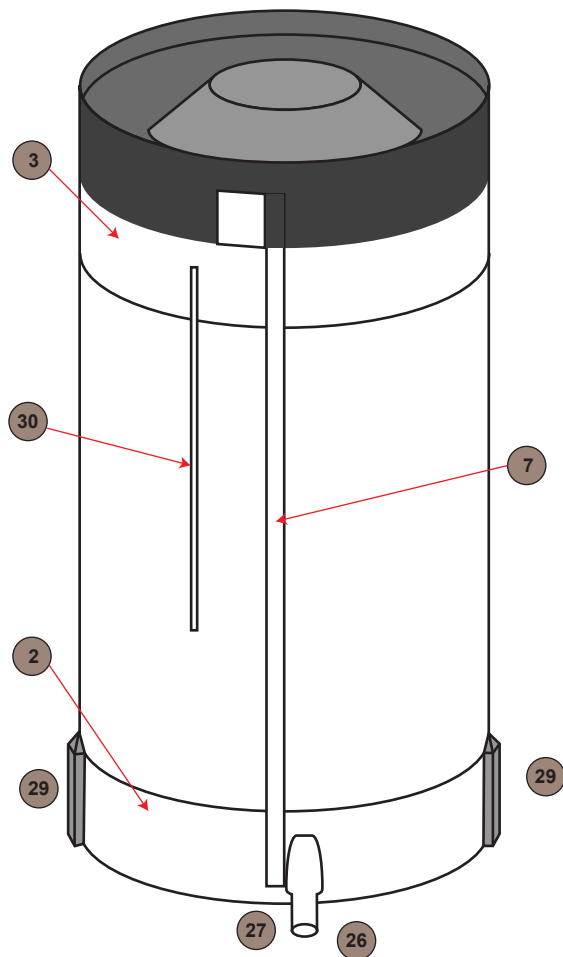
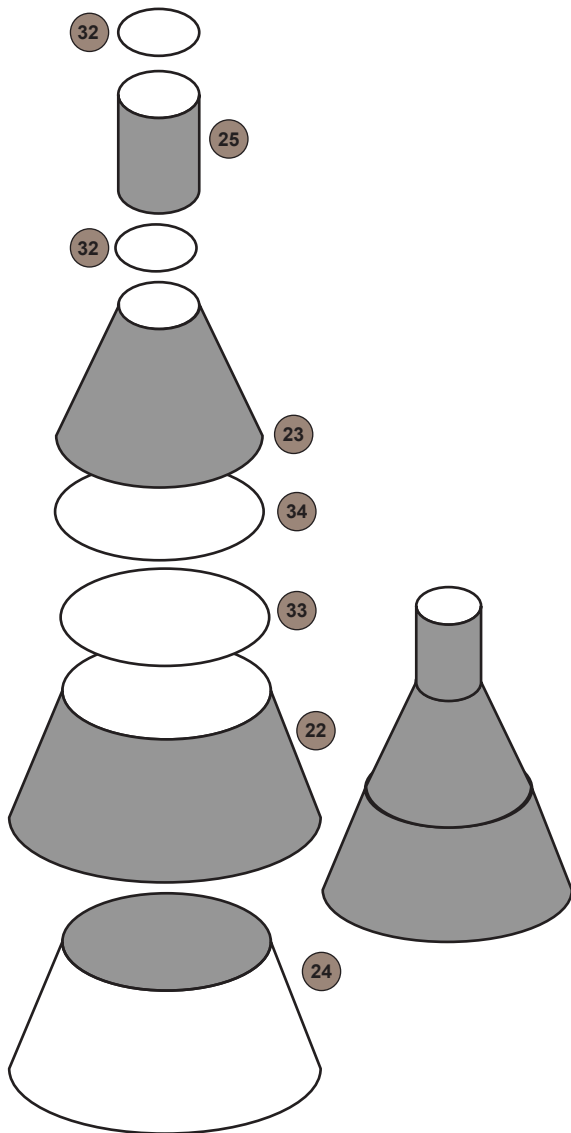



THIRD STAGE

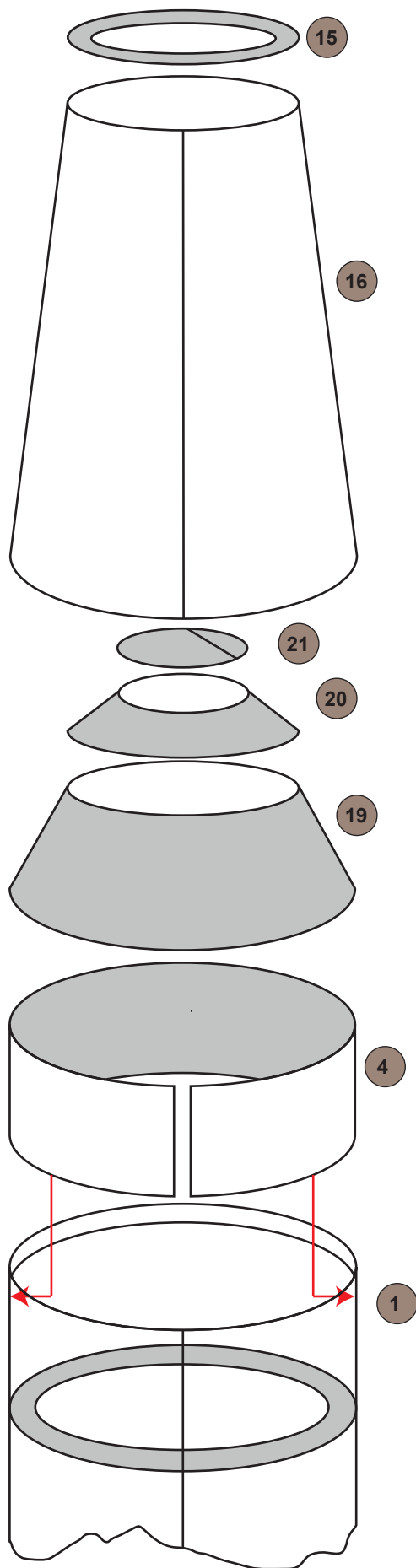
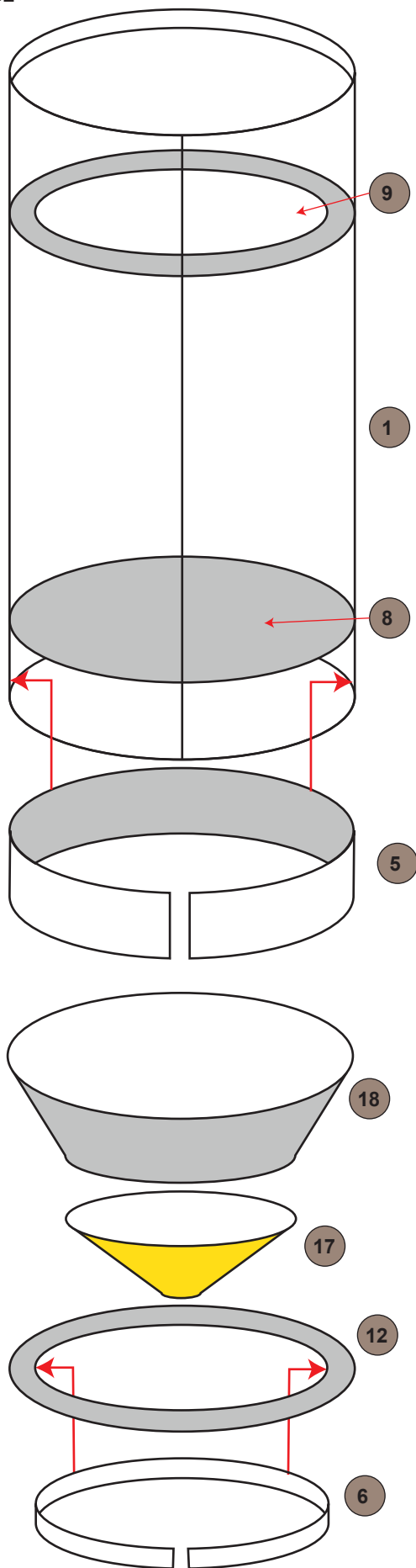



COMMAND MODULE

